

DATA SHEET

mifare DESFire

**Contactless Multi-Application IC
with DES and 3DES Security**

MF3 IC D40

Product Specification

April 2004

Revision 3.1

CONFIDENTIAL

Functional Specification**mifare DESFire MF3 IC D40****CONTENTS**

1	FEATURES.....	5
1.1	RF Interface: ISO 14443 Type A.....	5
1.2	ISO/IEC 7816 compatibility (only Software Version 0.6 and higher).....	5
1.3	Non - Volatile Memory	5
1.4	NV-Memory Organisation	5
1.5	Security.....	6
2	GENERAL DESCRIPTION	7
2.1	Contactless Energy and Data Transfer	7
2.2	Delivery Types	7
2.3	Anticollision.....	8
2.4	UID / Serial Number	8
2.5	Memory Organisation.....	8
2.6	Security Concept.....	9
2.7	(3)DES-Encryption	12
2.8	MACing.....	14
3	MF3 IC D40 – CODING OF SECURITY-, APPLICATION- AND FILE- RELATED FEATURES	15
3.1	Coding of File Types	15
3.2	Coding of Communication Settings – Encryption Modes	15
3.3	Coding of Access Rights	16
3.4	Coding of Status- and Error Codes.....	17
3.5	DESFire Command Set Overview - ISO 14443-3:.....	18
3.6	DESFire Command Set Overview - ISO 14443-4:.....	18
3.7	MF3 IC D40 Command Set Overview – Security Related Commands:.....	19
3.8	MF3 IC D40 Command Set Overview – PICC Level Commands:.....	19
3.9	MF3 IC D40 Command Set Overview – Application Level Commands:	20
3.10	MF3 IC D40 Command Set Overview – Data Manipulation Commands	21
3.11	ISO 7816-4 APDU Message Structure.....	22
3.12	Selection of native DESFire APDU Framing versus ISO 7816-4 framing and commands	22
3.13	Wrapping of native DESFire APDUs.....	23
3.14	Pre-Selection after entering 14443-4 (only in 7816-4 Framing mode).....	24
4	DESFIRE COMMAND SET	25
4.1	Command Set ISO 14443-3:	25
4.1.1	Request Type A (REQA)	25
4.1.2	Wake-Up (WUPA)	25

Functional Specification**mifare DESFire MF3 IC D40**

4.1.3	ANTICOLLISION and SELECT of Cascade Level 1	26
4.1.4	ANTICOLLISION and SELECT of Cascade Level 2	27
4.2	Command Set ISO 14443-4:	28
4.2.1	Request for Answer To Select (RATS).....	28
4.2.2	Protocol and Parameter Selection Request (PPS)	29
4.2.3	Frame Waiting Extensions (WTX).....	30
4.3	MF3 IC D40 Command Set – Security Related Commands:	31
4.3.1	Authenticate	31
4.3.2	ChangeKeySettings.....	33
4.3.3	GetKeySettings	36
4.3.4	ChangeKey	37
4.3.5	GetKeyVersion	39
4.4	MF3 IC D40 Command Set – PICC Level Commands:	40
4.4.1	CreateApplication.....	40
4.4.2	DeleteApplication	41
4.4.3	GetApplicationIDs.....	42
4.4.4	SelectApplication.....	43
4.4.5	FormatPICC	44
4.4.6	GetVersion	45
4.5	MF3 IC D40 Command Set – Application Level Commands:.....	47
4.5.1	GetFileIDs.....	47
4.5.2	GetFileSettings.....	48
4.5.3	ChangeFileSettings	50
4.5.4	CreateStdDataFile.....	51
4.5.5	CreateBackupDataFile	52
4.5.6	CreateValueFile	53
4.5.7	CreateLinearRecordFile	54
4.5.8	CreateCyclicRecordFile.....	55
4.5.9	DeleteFile.....	56
4.6	MF3 IC D40 Command Set – Data Manipulation Commands.....	57
4.6.1	ReadData.....	57
4.6.2	WriteData.....	59
4.6.3	GetValue.....	61
4.6.4	Credit.....	62
4.6.5	Debit.....	63
4.6.6	LimitedCredit.....	64

Functional Specification**mifare DESFire MF3 IC D40**

4.6.7	WriteRecord	65
4.6.8	ReadRecords	67
4.6.9	ClearRecordFile	69
4.6.10	CommitTransaction	70
4.6.11	AbortTransaction.....	71
4.7	Command Set ISO 7816-4 – Basic interindustry commands:	72
4.7.1	ISO SELECT APPLICATION command.....	72
4.7.2	ISO SELECT DIRECTORY command	73
4.7.3	ISO SELECT FILE command	74
4.7.4	ISO READ BINARY command.....	76
4.7.5	ISO UPDATE BINARY command	77
5	DEFINITIONS	78
6	LIFE SUPPORT APPLICATIONS.....	78
7	REVISION HISTORY	79
	Contact Information.....	80

Functional Specification

mifare DESFire MF3 IC D40

1 FEATURES

1.1 RF Interface: ISO 14443 Type A

- Contactless transmission of data and powered by the RF-field (no battery needed)
- Operating distance: Up to 100 mm (depending on antenna geometry)
- Operating frequency: 13.56 MHz
- Fast data transfer: 106 kbit/s, 212 kbit/s, 424 kbit/s
- High data integrity: 16 Bit CRC, parity, bit coding, bit counting
- True deterministic anticollision
- 7 byte unique identifier (cascade level two according to ISO 14443-3)
- Uses ISO 14443-4 protocol

1.2 ISO/IEC 7816 compatibility (only Software Version 0.6 and higher)

- Supports 7816-3 APDU message Structure
- Supports 7816-4 INS code 'A4' SELECT APPLICATION
- Supports 7816-4 INS code 'A4' SELECT DIRECTORY
- Supports 7816-4 INS code 'A4' SELECT FILE
- Supports 7816-4 INS code 'B0' READ BINARY
- Supports 7816-4 INS code 'D6' UPDATE BINARY

1.3 Non - Volatile Memory

- 4 kbyte NV-Memory
- NV-Memory write time 2 ms (1 ms erase, 1 ms program)
- Data retention of 10 years
- Write endurance 100 000 cycles

1.4 NV-Memory Organisation

- Flexible file system
- Up to 28 applications simultaneously on one PICC
- Up to 16 files in each application

Functional Specification**mifare DES*Fire* MF3 IC D40**

1.5 Security

- Unique 7 Byte serial number for each device
- Mutual three pass authentication
- Hardware DES/3DES Data encryption on RF-channel with replay attack protection using 56/112 bit Keys featuring key versioning
- Data Authenticity by 4 Byte MAC
- Authentication on Application level
- Hardware exception sensors
- Self-securing file system

Functional Specification

mifare DESFire MF3 IC D40

2 GENERAL DESCRIPTION

Philips has developed the MIFARE[®] DESFire (MF3 IC D40) to be used with Proximity Coupling Devices (PCDs) according to ISO14443 Type A. The communication protocol complies to part ISO 14443-4. The MF3 IC D40 is primarily designed for secure contactless transport applications and related loyalty programs.

In addition to ISO 14443 DESFire also support the use of ISO 7816-3 compliant APDU message structure.

2.1 Contactless Energy and Data Transfer

In the MIFARE[®] system, the MF3 IC D40 is connected to a coil consisting of a few turns embedded in a standard ISO smart card. No battery is needed. When the card is positioned in the proximity of the PCD antenna, the high speed RF communication interface allows to transmit data with up to 424 kbit/s.

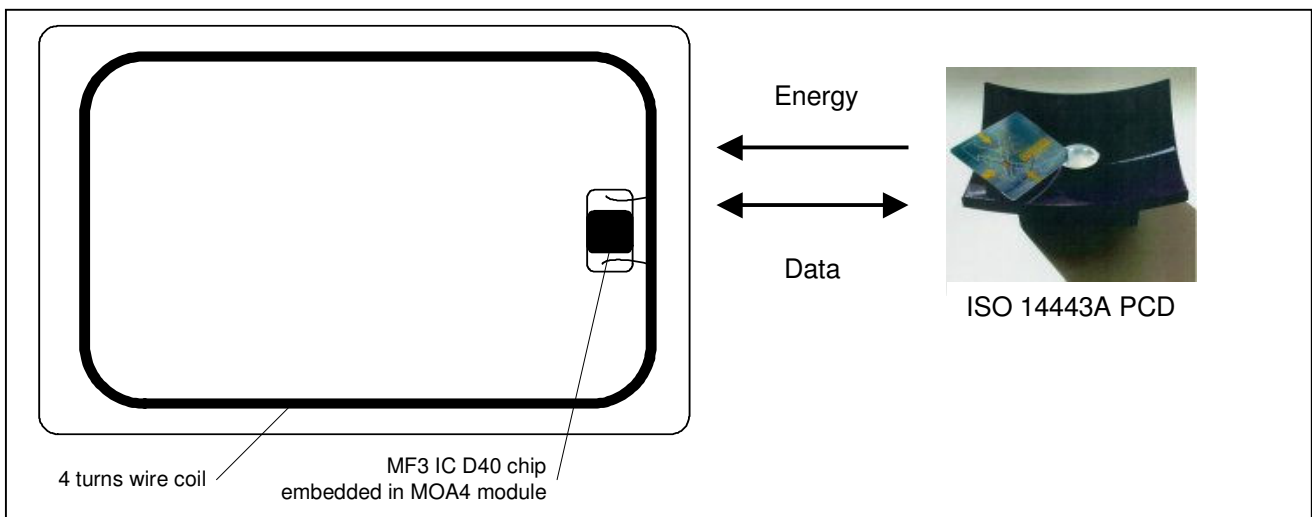

2.2 Delivery Types

- Dies on 8" wafer, sawn on FFC, 150µm thickness
- Au-Bumped Dies on 8" wafer, sawn on FFC, 150µm thickness
- MOA4 Contactless Chip Card Module

Functional Specification

mifare DESFire MF3 IC D40

2.3 Anticollision

An intelligent anticollision mechanism allows to handle more than one PICC in the field simultaneously. The anticollision algorithm selects each PICC individually and ensures that the execution of a transaction with a selected PICC is performed correctly without data corruption resulting from other PICCs in the field.

2.4 UID / Serial Number

The unique 7 byte serial number (UID) is programmed into a locked part of the NV-memory which is reserved for the manufacturer. Due to security and system requirements these bytes are write-protected after having been programmed by the IC manufacturer at production time.

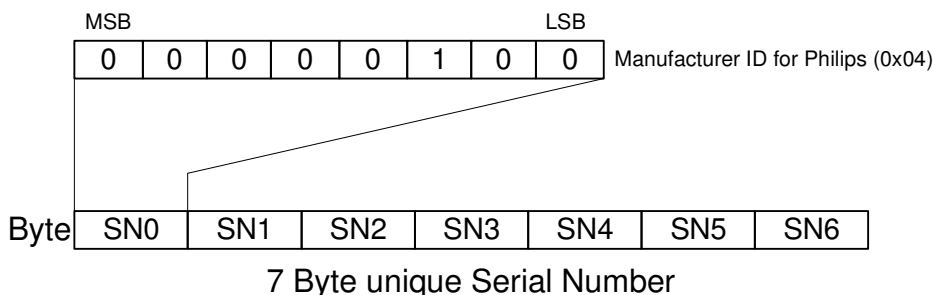

According to ISO14443-3 the first anticollision loop, see chapter 4.1.3, will return the cascade tag 0x88 and the first 3 bytes of the UID, SN0 to SN2 and BCC. The second anticollision loop, see chapter 4.1.4, will return bytes SN3 to SN6 and BCC.

SN0 holds the Manufacturer ID for Philips (04h) according to ISO14443-3 and ISO 7816-6 AMD 1.

2.5 Memory Organisation

The 4 kbyte NV-memory is organised using a flexible file system. This file system allows a maximum of 28 different applications on one single PICC. Each application provides up to 16 files. Every application is represented by its 3 bytes **Application Identifier, AID**.

Five different file types are supported, see chapter 3.1.

A guideline to assign DESFire AIDs can be found in the application note “mifare Application Directory, MAD”.

Each file can be created either at PICC initialisation (card production / card printing), at PICC personalisation (vending machine) or in the field.

If a file or application becomes obsolete in operation, it can be permanently invalidated.

Commands which have impact on the file structure itself (e.g. creation or deletion of applications, change of keys...) activate an automatic rollback mechanism, which protects the file structure from getting corrupted.

If this rollback is necessary, it is done without user interaction before carrying out further commands.

To ensure data integrity on application level, a transaction oriented backup is implemented for all file types with backup. It is possible to mix file types with and without backup within one application, whereby backup is possible only for files 0 .. 7, files 8 .. 15 do not feature backup mechanisms.

Functional Specification

mifare DESFire MF3 IC D40

2.6 Security Concept

The 7 byte UID is unchangeably programmed into each device during production. It cannot be altered and ensures the uniqueness of each device.

The UID may be used to derive diversified keys for each ticket. Diversified PICC keys contribute to gain an effective anti-cloning mechanism.

Prior to data transmission a mutual three pass authentication can be done between PICC and PCD depending on the configuration employing either DES or 3DES.

Three pass authentication proves that both parties (PCD and PICC) are in the position of a common secret (DES/3DES key), see chapter 4.3.1. The result of a successful authentication is a trusted link between both parties. The authentication command also yields a session key that you can use to protect the data transmission channel.

Below it is described in detail how the mutual 3-pass authentication procedure is done and how the session key is generated:

#	PCD	Data exchanged	PICC
1	<p>The reader device is always the entity which starts an authentication procedure. This is done by sending the command Authenticate. As parameter the key number is passed to the PICC in order to select a certain key stored in its NV-memory (up to 14 different keys per application). If the key number does not reflect a valid key in the PICC memory, an error code is sent by the PICC in response.</p> <p>Depending on the previously selected AID on the PICC, the subsequent authentication procedure is done for this specific AID.</p> <p>If the previously selected AID is 0x00, then the authentication is done using the PICC Master Key. In this case, the parameter key number has to be set to 0x00, too. (The possibilities and usage of the PICC Master Key is described later on.) After power up of the PICC the AID 0x00 is implicitly selected, which means that an Authenticate command after power-up always references the PICC Master Key.</p>	<p>→</p> <p>Authenticate (KeyNo)</p>	
2		<p>←</p> <p>8 bytes</p> <p>$ek_{keyNo}(RndB)$</p>	<p>After a specific key is selected, the PICC generates an 8 byte random number <i>RndB</i>. This random number is DES/3DES enciphered with the selected key, denoted by $ek_{keyNo}(RndB)$, and is then</p>

Functional Specification

mifare DESFire MF3 IC D40

#	PCD	Data exchanged	PICC
			transmitted to the PCD.
3	<p>The PCD runs a DES/3DES deciphering operation on the received $ek_{keyNo}(RndB)$ and thus retrieves $RndB$. (The used key for the deciphering obviously has to be the same as for the previous enciphering by the PICC.)</p> <p>In the next step $RndB$ is rotated left by 8 bits (first byte is moved to the end of $RndB$), yielding $RndB'$.</p> <p>Now the PCD itself generates an 8 byte random number $RndA$. This $RndA$ is concatenated with $RndB'$ and deciphered using DES/3DES (The decryption of the two blocks is chained using the Cipher Block Chaining (CBC) send mode). This token $dk_{keyNo}(RndA + RndB')$ is sent to the PICC.</p>	<p style="text-align: center;">→</p> <p style="text-align: center;">16 bytes</p> <p style="text-align: center;">$dk_{keyNo}(RndA + RndB')$</p>	
4		<p style="text-align: center;">←</p> <p style="text-align: center;">8 bytes</p> <p style="text-align: center;">$ek_{keyNo}(RndA')$</p>	<p>The PICC runs an DES/3DES encipherment on the received token and thus gains $RndA + RndB'$. The PICC can now verify the sent $RndB'$ by comparing it with the $RndB'$ obtained by rotating the original $RndB$ left by 8 bits internally.</p> <p>A successful verification proves to the PICC that the PICC and the PCD posses the same secret (key).</p> <p>If the verification fails, the PICC stops the authentication procedure and returns an error message.</p> <p>As the PICC also received the random number $RndA$, generated by the PCD, it can perform a rotate left operation by 8 bits on $RndA$ to gain $RndA'$, which is enciphered again, resulting in $ek_{keyNo}(RndA')$. This token is sent to the PCD.</p>
5	<p>The PCD runs a DES/3DES decipherment on the received $ek_{keyNo}(RndA')$ and thus gains $RndA'$ for comparison with the PCD-internally rotated $RndA'$.</p> <p>If the comparison fails, the PCD exits the procedure and may halt the PICC.</p>		
6			The PICC sets the authentication state for

Functional Specification

mifare DESFire MF3 IC D40

#	PCD	Data exchanged	PICC
			the currently selected application or the PICC itself (in case of AID=0x00).
7	<p>If all comparisons are successful, the 16 byte session key is obtained by employing <i>RndA</i> and <i>RndB</i>. The session key is gained by combining them according to the following rule:</p> $\text{session key} := \text{RndA}_{1\text{st half}} + \text{RndB}_{1\text{st half}} + \text{RndA}_{2\text{nd half}} + \text{RndB}_{2\text{nd half}}$ <p>This scrambling of <i>RndA</i> and <i>RndB</i> is done to avoid that a malicious PCD could degenerate 3DES cryptography to single DES operation by forcing <i>RndA</i> = <i>RndB</i>.</p> <p>In case of WANTED single DES operation (leading 8 bytes of the secret key are identical to the trailing 8 bytes), only the first 8 bytes of the session key ($\text{RndA}_{1\text{st half}} + \text{RndB}_{1\text{st half}}$) are used for further cryptographic operations, the trailing 8 bytes must not be used.</p> <p>With the generation of the session key the mutual 3-pass authentication is successfully completed.</p>		

Data Transmission between PICC and PCD can be done on three levels of security:

- Plain data transfer
- Plain data transfer with DES/3DES cryptographic checksum (MAC)
- DES/3DES encrypted data transfer (secured by CRC before encryption)

Access to user data is granted on application level. For each application up to 14 different user definable keys can be assigned to control access to data stored in the PICC.

Functional Specification

mifare DESFire MF3 IC D40

2.7 (3)DES-Encryption

The DES standard defines two basic cryptographic operations: **encipherment** and **decipherment**.

The DESFire device always performs the cryptographic operation “**encipherment**” on any received and sent data. This avoids time-consuming key-re-loading to the DESFire 3DES hardware.

This implicates that the PCD always needs to use the **decipher** cryptographic operation to **decipher** data received from DESFire respectively needs to use the **decipher** cryptographic operation to **decipher** data before sending to DESFire.

3DES operation	PICC	PCD
Key1= 1 st 8 bytes of 3DES Key	Encipher	Decipher
Key2= 2 nd 8 bytes of 3DES Key	Decipher	Encipher
Key3= 1 st 8 bytes of 3DES Key	Encipher	Decipher

DES/3DES always operates on 8 bytes. Therefore data streams are always padded to a length of multiples of 8 bytes.

All cryptographic operations are done in “cipher block chaining mode”, which defines the result of the previous operation to be the Init-vector of the next cryptographic operation. For sending data the "CBC send mode" is used, for receiving always "CBC receive mode".

The Init-vector to start cryptographic operation is defined as "0x00 00 00 00 00 00 00 00".

Data is prepared in following way:

- A CRC16 (according to ISO14443A) is added to the data.
- For DES operation the length of data has to be equal to n*8 Bytes, so the data is filled up to n*8 Bytes with "0x00" (=“padding”).
- These n*8 bytes are en-/deciphered in CBC mode.
- Length of resulting data is always n*8 bytes.

Note: In case the length of data in the DESFire command is given with "0x00 00 00" (all data bytes have to be read), padding to n*8 Bytes has to be done with once "0x80" and the rest "0x00".

The original DES standard specifies one parity bit for every byte in the DES key, causing an overhead of 8 bits per DES key. Modern 3DES Hardware does not need parity bits any more to ensure data integrity. DESFire uses these bits to store one byte of data that can be used to store the version of the key. This is called key versioning. When you write a key to key to DESFire, you always write this version information (in your key generation process, make sure you overwrite the parity bits with the key version, otherwise you endanger the security level of your cryptographic system, as the parity bits (= key version) can be read with the GetKeyVersion command, see chapter 4.3.5.

To store a key version to the PICC, the new version number needs to be coded by the application software into the new key before issuing the ChangeKey command. The key version information is NOT checked by the PICC in any respect.

Functional Specification**mifare DES*Fire* MF3 IC D40**

Important Note:

Even if the Key versioning feature is NOT used, the application needs to make sure that the **parity bits** of every single byte in the new DES / 3DES key are **overwritten with a default value** (e.g. "0") as they can be read out using the GetKeyVersion command.

In case the parity information is not overwritten, the valid parity bits are returned., which significantly decreases the cryptographic strength of the key.

Functional Specification

mifare DESFire MF3 IC D40

2.8 MACing

The DES standard defines two basic cryptographic operations: **encipherment** and **decipherment**.

The DESFire device always performs the cryptographic operation “**encipherment**” on any received and sent data. This avoids time-consuming key-re-loading to the DESFire 3DES hardware.

This implicates that for calculation of a MAC the PCD also always needs to **encipher** data received from DESFire respectively needs to **encipher** data before sending to DESFire.

3DES operation	PICC	PCD
Key1= 1 st 8 bytes of 3DES Key	Encipher	Encipher
Key2= 2 nd 8 bytes of 3DES Key	Decipher	Decipher
Key3= 1 st 8 bytes of 3DES Key	Encipher	Encipher

DES/3DES always operates on 8 bytes. Therefore data streams are always padded to a length of multiples of 8 bytes.

All cryptographic operations are done in “cipher block chaining mode”, which defines the result of the previous operation to be the Init-vector of the next cryptographic operation as. For generating MACs the “CBC send mode” is used.

The Init-vector to start cryptographic operation is defined as “0x00 00 00 00 00 00 00 00”

Data is prepared in following way:

- NO CRC is added to the data.
- For DES operation the length of data has to be equal to n*8 Bytes, so the data is filled up to n*8 Bytes with “0x00” (=“padding”).
- This n*8 bytes are en-/deciphered in CBC mode.
- The first 4 bytes of the last 8 byte outcome block is defined as MAC.
- This 4 bytes MAC is added to and checked across the transferred **plain** data.
- Length of resulting data is always initial data length + 4 bytes MAC.

Functional Specification

mifare DESFire MF3 IC D40

3 MF3 IC D40 – CODING OF SECURITY-, APPLICATION- AND FILE- RELATED FEATURES

3.1 Coding of File Types

The files within an application can be of different types as:

- Standard Data Files (coded as 0x00)
- Backup Data Files (coded as 0x01)
- Value Files with Backup (coded as 0x02)
- Linear Record Files with Backup (coded as 0x03)
- Cyclic Record Files with Backup (coded as 0x04)

3.2 Coding of Communication Settings – Encryption Modes

The Communication Settings define the level of security for the communication between PCD and PICC. Communication Settings always apply on file-level.

The Settings are coded into one byte which needs to be set to

Communication Mode	bit 7 – bit 2	bit 1	bit 0
Plain communication	RFU = 0	ignored	0
Plain communication secured by DES/3DES MACing	RFU = 0	0	1
Fully DES/3DES enciphered communication	RFU = 0	1	1

Both DES and 3DES keys are stored in strings consisting of 16 bytes:

If the 2nd half of the key string is equal to the 1st half, the key is handled as a single DES key by the PICC.

If the 2nd half of the key string is **not** equal to the 1st half, the key is handled as a 3DES key.

Examples for single DES keys: 0x00 11 22 33 44 55 66 77 00 11 22 33 44 55 66 77
 0x00 00 00 00 00 00 00 00 00 00 00 00 00 00 00 00 *

Examples for 3DES keys: 0x00 11 22 33 44 55 66 77 88 99 AA BB CC DD EE FF
 0x00 11 22 33 44 55 66 77 00 00 00 00 00 00 01 00
 0x00 00 00 00 00 00 00 00 00 00 00 01 00 00 00 00

* All bytes 0x00 is the default key of the MF3 IC D40 IC, and defines single DES operation as default.

All operations based on keys are executed with the respective method DES or 3DES.

Functional Specification

mifare DESFire MF3 IC D40

3.3 Coding of Access Rights

There are four different Access Rights (2 bytes for each file) stored for each file within each application:

- Read Access (GetValue, Debit for Value files)
- Write Access (GetValue, Debit, LimitedCredit for Value files)
- Read&Write Access (GetValue, Debit, LimitedCredit, Credit for Value files)
- ChangeAccessRights

Each of the Access Rights is coded in 4 bits, one nibble. Each nibble represents a link to one of the keys stored within the respective application's key file.

One nibble allows to code 16 different values. If such a value is set to a number between 0 and 13 (max. 14 keys), this references a certain key within the application's key file, provided that the key exists (selecting a non-existing key is not allowed).

If the number is coded as 14 (0xE) this means "free" access. Thus the regarding access is granted always with and without a preceding authentication, directly after the selection of the respective application.

The number 15 (0xF) defines the opposite of "free" access and has the meaning "deny" access. Therefore the respective linked Access Rights is always denied.

The most significant 4 bits of the two bytes parameter code the reference number of the key which is necessary to know for getting Read Access (in case of Value files: for the GetValue and the Debit Command).

The next 4 bits hold the number of the key for getting Write Access (in case of Value files: GetValue, Debit and LimitedCredit Command).

The upper nibble of the lower byte holds the key number for getting Read&Write Access, in Value files this right allows full access (in case of Value files: GetValue, Debit, LimitedCredit and Credit Command; in case of Record files additionally: ClearRecordFile).

The least significant nibble holds the reference number of the key, which is necessary to be authenticated with in order to change the Access Rights for the file and to link each Access Right to key numbers.

Access rights are always packed in 2 bytes as follows:

15	12 11	8 7	4 3	0
Read Access	Write Access	Read&Write Access	Change Access Rights	
MS Bit			LS Bit	

Read is possible with Read Access and Read&Write Access.

Write is possible with Write Access and Read&Write Access.

If a file is accessed without valid authentication but free access (0xE) is possible through at least one relevant access right, the communication mode is forced to plain.

If only one of the keys for "Read" and "Read&Write" access (or "Write" and "Read&Write" access) is set to 0xE, the other key is different from 0xE, communication is done MACed/enciphered in case of a valid authentication and done in plain in case of no valid authentication. In the second case the communication settings, see chapter 3.2, are ignored by the PICC.

Functional Specification

mifare DESFire MF3 IC D40

3.4 Coding of Status- and Error Codes

Hex code	Status	Description
0x00	OPERATION_OK	Successful operation
0x0C	NO_CHANGES	No changes done to backup files, CommitTransaction / AbortTransaction not necessary
0x0E	OUT_OF_EEPROM_ERROR	Insufficient NV-Memory to complete command
0x1C	ILLEGAL_COMMAND_CODE	Command code not supported
0x1E	INTEGRITY_ERROR	CRC or MAC does not match data Padding bytes not valid
0x40	NO_SUCH_KEY	Invalid key number specified
0x7E	LENGTH_ERROR	Length of command string invalid
0x9D	PERMISSION_DENIED	Current configuration / status does not allow the requested command
0x9E	PARAMETER_ERROR	Value of the parameter(s) invalid
0xA0	APPLICATION_NOT_FOUND	Requested AID not present on PICC
0xA1	APPL_INTEGRITY_ERROR	Unrecoverable error within application, application will be disabled *
0xAE	AUTHENTICATION_ERROR	Current authentication status does not allow the requested command
0xAF	ADDITIONAL_FRAME	Additional data frame is expected to be sent
0xBE	BOUNDARY_ERROR	Attempt to read/write data from/to beyond the file's/record's limits. Attempt to exceed the limits of a value file.
0xC1	PICC_INTEGRITY_ERROR	Unrecoverable error within PICC, PICC will be disabled *
0xCA	COMMAND_ABORTED	Previous Command was not fully completed Not all Frames were requested or provided by the PCD
0xCD	PICC_DISABLED_ERROR	PICC was disabled by an unrecoverable error *
0xCE	COUNT_ERROR	Number of Applications limited to 28, no additional CreateApplication possible
0xDE	DUPLICATE_ERROR	Creation of file/application failed because file/application with same number already exists
0xEE	EEPROM_ERROR	Could not complete NV-write operation due to loss of power, internal backup/rollback mechanism activated *
0xF0	FILE_NOT_FOUND	Specified file number does not exist
0xF1	FILE_INTEGRITY_ERROR	Unrecoverable error within file, file will be disabled *

* These errors are not expected to appear during normal operation.

Functional Specification

mifare DESFire MF3 IC D40

3.5 DESFire Command Set Overview - ISO 14443-3:

Command	Description
REQA	REQA and ATQA are implemented fully according to ISO14443-3.
WUPA	WAKE-UP is implemented fully according to ISO14443-3.
ANTICOLLISION / SELECT Cascade Level 1	The ANTICOLLISION and SELECT commands are implemented fully according to ISO14443-3. The response is part 1 of the UID.
ANTICOLLISION / SELECT Cascade Level 2	The ANTICOLLISION and SELECT commands are implemented fully according to ISO14443-3. The response is part 2 of the UID.

3.6 DESFire Command Set Overview - ISO 14443-4:

Command	Description
RATS	The response to the RATS command identifies the PICC type to the PCD.
PPS	The PPS command allows to individually select the communication baud rate between PCD and PICC. For DESFire it is possible to individually set the communication baud rate independently for both directions i.e. DESFire allows a non-symmetrical information interchange speed.
WTX	If the PICC needs more time than the defined FWT to respond to a PCD command it will send a request for a waiting time extension.

Functional Specification

mifare DESFire MF3 IC D40

3.7 MF3 IC D40 Command Set Overview – Security Related Commands:

Hex	Command	Description
0x0A	Authenticate	In this procedure both, the PICC as well as the reader device, show in an encrypted way that they possess the same secret which especially means the same key. This procedure not only confirms that both entities are permitted to do operations on each other but also creates a session key which can be used to keep the further communication path secure. As the name “session key” implicitly indicates, each time a new authentication procedure is successfully completed a new key for further cryptographic operations is generated.
0x54	Change KeySettings	Changes the master key settings on PICC and application level.
0x45	Get KeySettings	Gets information on the PICC and application master key settings. In addition it returns the maximum number of keys which can be stored within the selected application.
0xC4	Change Key	Changes any key stored on the PICC.
0x64	Get KeyVersion	Reads out the current key version of any key stored on the PICC.

Note: All command & data frames are exchanged between PICC and PCD by using block format as defined in ISO 14443-4.

3.8 MF3 IC D40 Command Set Overview – PICC Level Commands:

Hex	Command	Description
0xCA	Create Application	Creates new applications on the PICC.
0xDA	Delete Application	Permanently deactivates applications on the PICC.
0x6A	Get Applications IDs	Returns the Application IDentifiers of all applications on a PICC.
0x5A	Select Application	Selects one specific application for further access.
0xFC	FormatPICC	Releases the PICC user memory.
0x60	Get Version	Returns manufacturing related data of the PICC.

Note: All command & data frames are exchanged between PICC and PCD by using block format as defined in ISO 14443-4.

Functional Specification

mifare DESFire MF3 IC D40

3.9 MF3 IC D40 Command Set Overview – Application Level Commands:

Hex	Command	Description
0x6F	Get FileIDs	Returns the File IDentifiers of all active files within the currently selected application.
0xF5	Get FileSettings	Get information on the properties of a specific file.
0x5F	Change FileSettings	Changes the access parameters of an existing file.
0xCD	Create StdDataFile	Creates files for the storage of plain unformatted user data within an existing application on the PICC.
0xCB	Create BackupDataFile	Creates files for the storage of plain unformatted user data within an existing application on the PICC, additionally supporting the feature of an integrated backup mechanism.
0xCC	Create ValueFile	Creates files for the storage and manipulation of 32bit signed integer values within an existing application on the PICC.
0xC1	Create LinearRecordFile	Creates files for multiple storage of structural similar data, for example for loyalty programs, within an existing application on the PICC. Once the file is filled completely with data records, further writing to the file is not possible unless it is cleared.
0xC0	Create CyclicRecordFile	Creates files for multiple storage of structural similar data, for example for logging transactions, within an existing application on the PICC. Once the file is filled completely with data records, the PICC automatically overwrites the oldest record with the latest written one. This wrap is fully transparent for the PCD.
0xDF	DeleteFile	Permanently deactivates a file within the file directory of the currently selected application.

Note: All command & data frames are exchanged between PICC and PCD by using block format as defined in ISO 14443-4.

Functional Specification

mifare DESFire MF3 IC D40

3.10 MF3 IC D40 Command Set Overview – Data Manipulation Commands

Hex	Command	Description
0xBD	Read Data	Reads data from Standard Data Files or Backup Data Files.
0x3D	Write Data	Writes data to Standard Data Files or Backup Data Files.
0x6C	Get Value	Reads the currently stored value from Value Files.
0x0C	Credit	Increases a value stored in a Value File.
0xDC	Debit	Decreases a value stored in a Value File.
0x1C	Limited Credit	Allows a limited increase of a value stored in a Value File without having full Credit permissions to the file.
0x3B	Write Record	Writes data to a record in a Cyclic or Linear Record File.
0xBB	Read Records	Reads out a set of complete records from a Cyclic or Linear Record File.
0xEB	Clear RecordFile	Resets a Cyclic or Linear Record File to empty state.
0xC7	Commit Transaction	Validates all previous write access' on Backup Data Files, Value Files and Record Files within one application.
0xA7	Abort Transaction	In validates all previous write access' on Backup Data Files, Value Files and Record Files within one application.

Note: All command & data frames are exchanged between PICC and PCD by using block format as defined in ISO 14443-4.

Functional Specification

mifare DESFire MF3 IC D40

3.11 ISO 7816-4 APDU Message Structure

DESFire supports the APDU message structure according to ISO 7816-4 for

- an optional wrapping of the native DESFire APDU format
- for the additionally implemented 7816-4 commands, as described later on.

3.12 Selection of native DESFire APDU Framing versus ISO 7816-4 framing and commands

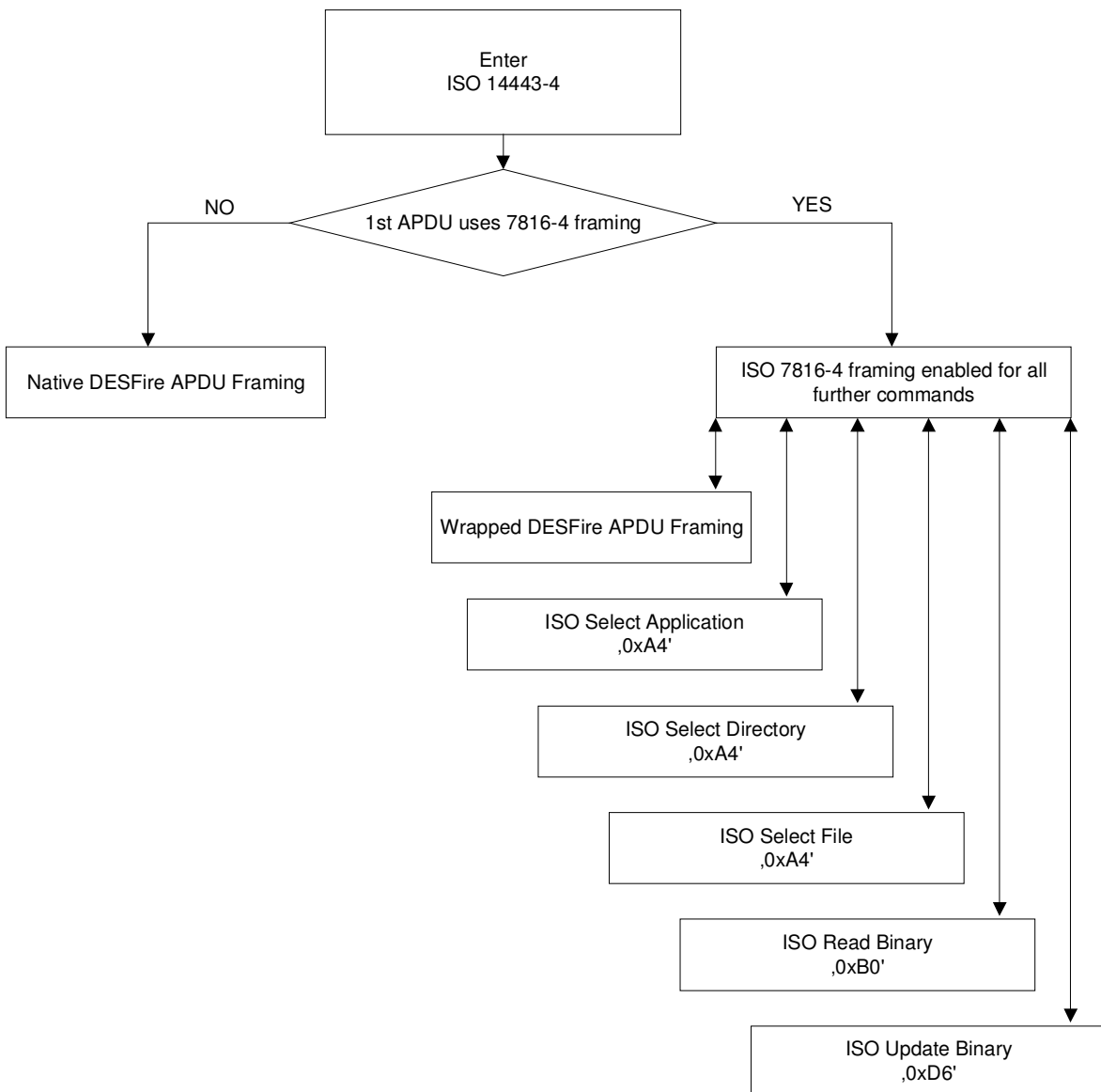

Functional Specification

mifare *DESFire* MF3 IC D40

3.13 Wrapping of native *DESFire* APDUs

Wrapping of the native *DESFire* APDU Format is done as a "case 4" 7816-4 APDU message structure:

CLA	INS	P1	P2	L _c	Data	L _E
0x90	<i>DESFire</i> CMD Code	0x00	0x00	Length of wrapped data	<i>DESFire</i> command parameter(s)	0x00

Note: The L_E byte set to 0x00 defined that any length of the PICC response is allowed.

Note: Other values than 0x00 are ignored by the PICC.

The Response of *DESFire* is wrapped as follows:

Data	SW1	SW2	Remarks
<i>DESFire</i> Response Data	0x91	0xYY	The SW2 byte holds the Status byte of native <i>DESFire</i>

Functional Specification

mifare DESFire MF3 IC D40

3.14 Pre-Selection after entering 14443-4 (only in 7816-4 Framing mode)

If the first APDU after establishing successfully ISO 14443-4 uses 7816-4 compliant framing, in general, an ISO SELECT APPLICATION command is required as first step in communication.

For legacy support, DESFire allows to skip this ISO SELECT APPLICATION command as the DESFire activates per default the DESFire AID, see chapter 4.7.1.

For enhanced legacy support, DESFire allows to skip the ISO SELECT DIRECTORY command.

In this case, an explicit ISO SELECT FILE command needs to be issued, as this command implicitly selects a DESFire AID, see chapter 4.7.3.

NOTE: For maximum compatibility with future versions of DESFire (or DESFire emulations on Dual Interface Smart Cards) we do NOT recommend to use this legacy features in newly designed applications.

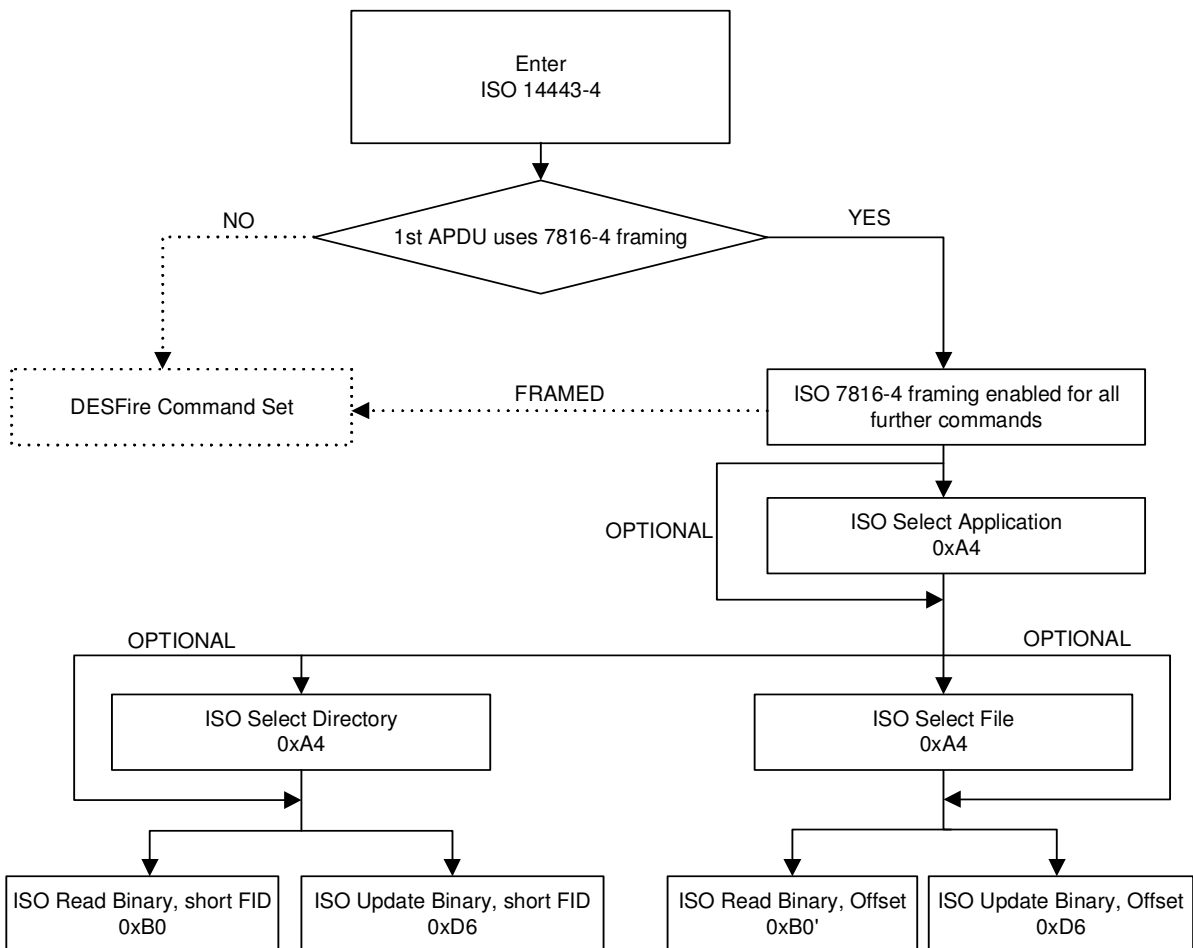

Functional Specification

mifare DESFire MF3 IC D40

4 DESFIRE COMMAND SET

4.1 Command Set ISO 14443-3:

The MF3 IC D40 accepts the following command set according to ISO 14443-3 activation:

4.1.1 Request Type A (REQA)

Code	Parameter	Data	Integrity mechanism	Response
26 (7 Bit)	-	-	-	0344

Description: The MF3 IC D40 accepts the REQA command in Idle state only. The response is the 2-byte ATQA (0344). REQA and ATQA are implemented fully according to ISO14443-3.

REQA:

Note: Times units are not drawn to scale!

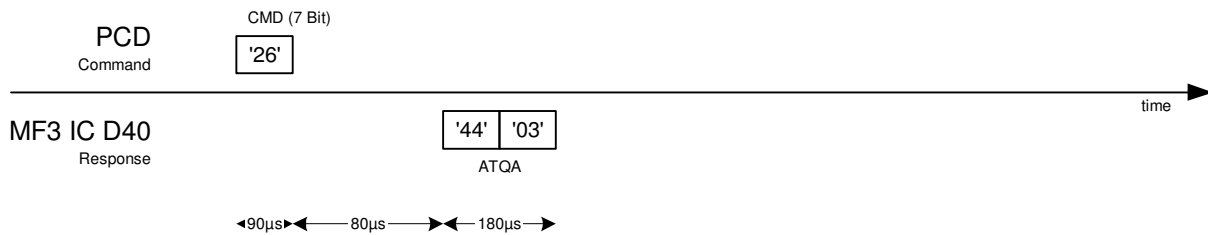

4.1.2 Wake-Up (WUPA)

Code	Parameter	Data	Integrity mechanism	Response
52 (7Bit)	-	-	-	0344

Description: The MF3 IC D40 accepts the WAKE-UP command in the Idle and Halt state only. The response is the 2-byte ATQA (0344). WAKE-UP is implemented fully according to ISO14443-3.

WAKE-UP



Functional Specification

mifare DESFire MF3 IC D40

4.1.3 ANTICOLLISION and SELECT of Cascade Level 1

Code	Parameter	Data	Integrity mechanism	Response
Anticollision: 93	20 – 67	Part of the UID	Parity	Parts of UID
Select: 93	70	Cascade Tag, First 3 bytes of UID	Parity, BCC, CRC	SAK (24)

Description: The ANTICOLLISION and SELECT commands are based on the same command code. They differ only in the Parameter byte. This byte is per definition 70 in case of SELECT. The MF3 IC D40 accepts these commands in the Ready1 state only. The response is part 1 of the UID.

For more details on the possible parameters please see ISO 14443-3.

ANTICOLLISION of Cascade Level1

Note: Times units are not drawn to scale!

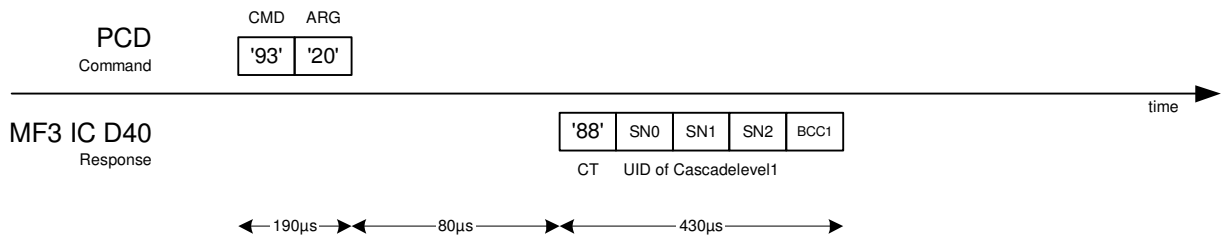

SELECT of Cascade Level1

Note: Times units are not drawn to scale!

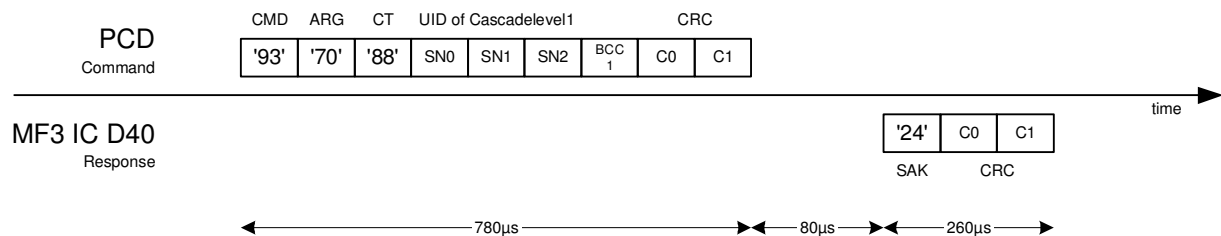

Functional Specification

mifare DESFire MF3 IC D40

4.1.4 ANTICOLLISION and SELECT of Cascade Level 2

Code	Parameter	Data	Integrity mechanism	Response
Anticollision: 0x95	20 – 67	Part of the UID	Parity	Parts of UID
Select: 0x95	70	Second 4 bytes of UID	Parity, BCC, CRC	SAK (20)

Description: The ANTICOLLISION and SELECT command are based on the same command code. They differ only in the parameter byte. This byte is per definition 70 in case of SELECT. The MF3 IC D40 accepts these commands in the Ready2 state only. The response is part 2 of the UID.

For more details on the possible parameters please see ISO 14443-3.

ANTICOLLISION of Cascade Level2

Note: Times units are not drawn to scale!

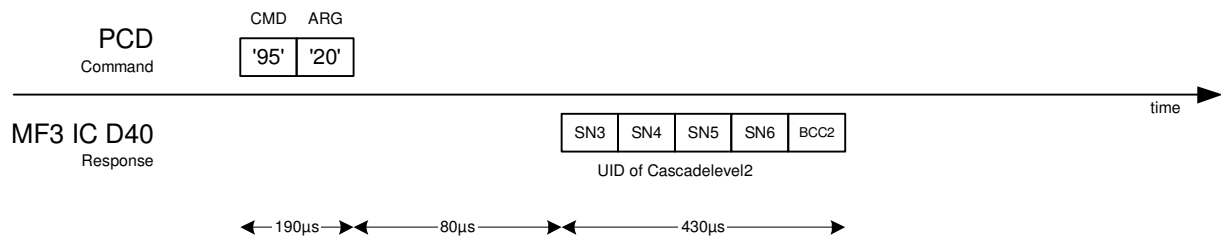

SELECT of Cascade Level2

Note: Times units are not drawn to scale!

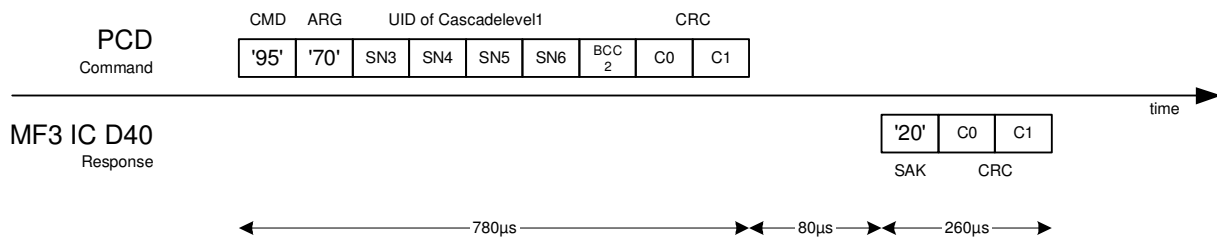

Functional Specification

mifare DESFire MF3 IC D40

4.2 Command Set ISO 14443-4:

The MF3 IC D40 provides the following command set according to ISO 14443-4:

4.2.1 Request for Answer To Select (RATS)

Code	Parameter	Data	Integrity mechanism	Response
0xE0	High Nibble: FSDI Low Nibble: CID	-	CRC	16 Byte Data

Description: The response to the RATS command communicates the PICC capabilities to the PCD. The parameter byte codes two different parameters for communication:

- FSDI: The High Nibble of the parameter byte codes the maximum frame size supported by the PCD for communication with the PICC.
- CID: The Low Nibble of the parameter byte codes the logical number of the addressed PICC. This logical number is in the range from 0x00 to 0x0E. This CID is used to distinguish several PICCs simultaneously selected by a single PCD. The DESFire PICC fully supports CIDs, which is coded in TC(1).

RATS

Note: Times units are not drawn to scale!

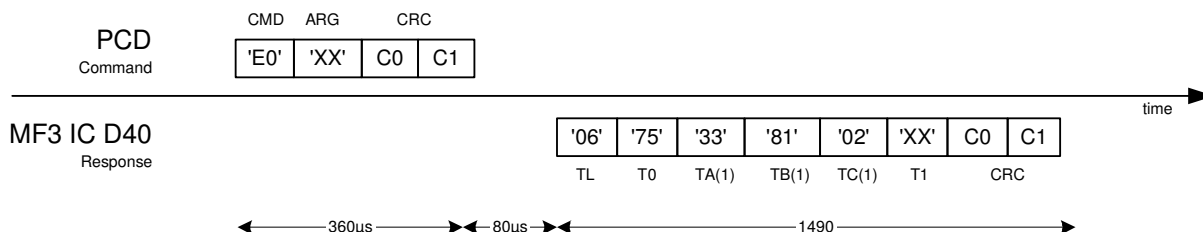

The response of the MF3 IC D40 to the RATS is the 'Answer to Select', ATS. This ATS consists of the following bytes:

TL: 'Length Byte', the length byte TL specifies the length of the transmitted ATS including itself. The two CRC bytes are not included in TL. For the MF3 IC D40 device TL is set to 0x06.

T0: 'Format Byte', the format bytes defines the presence of the subsequent bytes TA(1), TB(1) and TC(1). All three are present, resulting is 0x7 for the higher nibble. The lower nibble (FSCI) specifies the maximum size of a frame accepted by the MF3 IC D40 which is 64 bytes, coded as 0x5. The format byte therefore is 0x75.

TA(1): The 'Interface byte TA(1)' codes the maximum possible data rates supported by the PICC. As the MF3 IC D40 supports data rates up to 424 kbaud in both directions (PICC to PCD and PCD to PICC), the TA(1) byte is set to 0x33.

TB(1): The higher nibble codes the Frame Waiting Time (FWT), which is set to 0x8 for DESFire, indicating 77.33 ms. The lower nibble codes the start-up frame guard time (SFGT). It is set to 0x1, indicating 604µs. The PCD will therefore receive 0x81.

TC(1): CID is supported, NAD is not supported, therefore TC(1) is set to 0x02.

T1: The DESFire PICC sends one byte as historical character which should be ignored by the application software.

Functional Specification

mifare DESFire MF3 IC D40

4.2.2 Protocol and Parameter Selection Request (PPS)

Code	Parameter	Data	Integrity mechanism	Response
'PPSS: 'DX	PPS0 PPS1	-	CRC	PPSS: 'D0'

Description: The PPS command allows to individually select the communication baud rate between PCD and PICC. For DESFire it is possible to individually set the communication baud rate independently for both directions i.e. DESFire allows a non-symmetrical information interchange speed.

- **PPSS:** The higher nibble of the PPSS byte needs to be set to 'D', all other values are RFU. The lower nibble indicates the CID of the selected PICC in the range of 0x00 and 0x0E.
- **PPS0:** The PPS Parameter 0 byte indicates the presence of PPS1 (which is valid for DESFire) and therefore has to be set to 0x11.
- **PPS1:** The PPS Parameter 1 byte defines the divisor integer for timings between PCD and PICC which directly defines the baud rate in each direction.

The higher nibble of the PPS1 byte is RFU and has to be set to '0'. Bits b3 and b2 code the divisor integer from PICC to PCD and are called DSI. Bits b1 and b0 code the divisor integer from PCD to PICC and are called DRI.

The coding of DRI and DSI is done as specified below:

DRI, DSI bit coding	00	01	10
Divisor	1	2	4
Resulting Baud Rate	106 kbaud	212 kbaud	424 kbaud

DESFire supports baud rates up to 424 kbaud in both directions. please note that it is possible to independently set the communication speed in both directions, which allows for example to use 106 kbaud for communication from PCD to PICC (DRI=00) and 424 kbaud from PICC to PCD (DSI=10).

For communication with 106 kbaud in both directions the value of PPS1 has to be '00', which is the default if no PPS command is sent to the PICC.

PPS

Note: Times units are not drawn to scale!

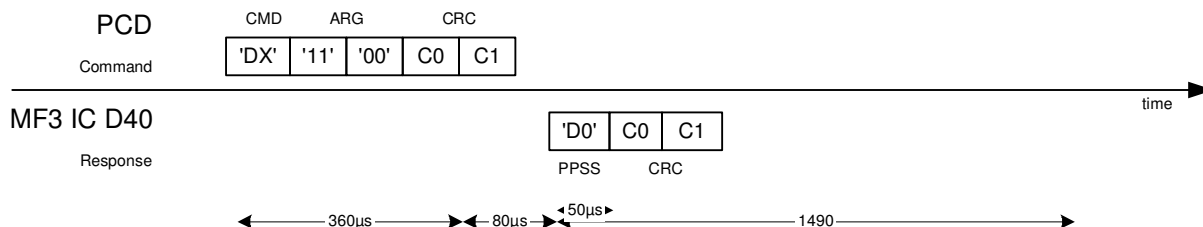

The response of the MF3 IC D40 to the PSS command is the PPS Start byte (PPSS, 0xD0). Invalid PPS requests are ignored (as defined in ISO).

Functional Specification**mifare DESFire MF3 IC D40**

4.2.3 Frame Waiting Extensions (WTX)

If the PICC needs more time than the defined FWT to respond to a PCD command it will send a request for a waiting time extension.

A 14443-4 S-block is sent by the PICC. According to ISO the INF field will contain the value 0x01, requesting another FWT interval.

The PCD has to confirm the request by sending another S-block either confirming 0x01 in the INF field.

Functional Specification

mifare DESFire MF3 IC D40

4.3 MF3 IC D40 Command Set – Security Related Commands:

The MF3 IC D40 provides the following command set for security related functions:

4.3.1 Authenticate

In this procedure both, the PICC as well as the reader device, show in an encrypted way that they possess the same secret which especially means the same key. This procedure not only confirms that both entities can trust each other but also generates a session key which can be used to keep the further communication path secure. As the name “session key” implicitly indicates, each time a new authentication procedure is successfully completed a new key for further cryptographic operations is obtained.

Authenticate(keyNo) [2bytes]

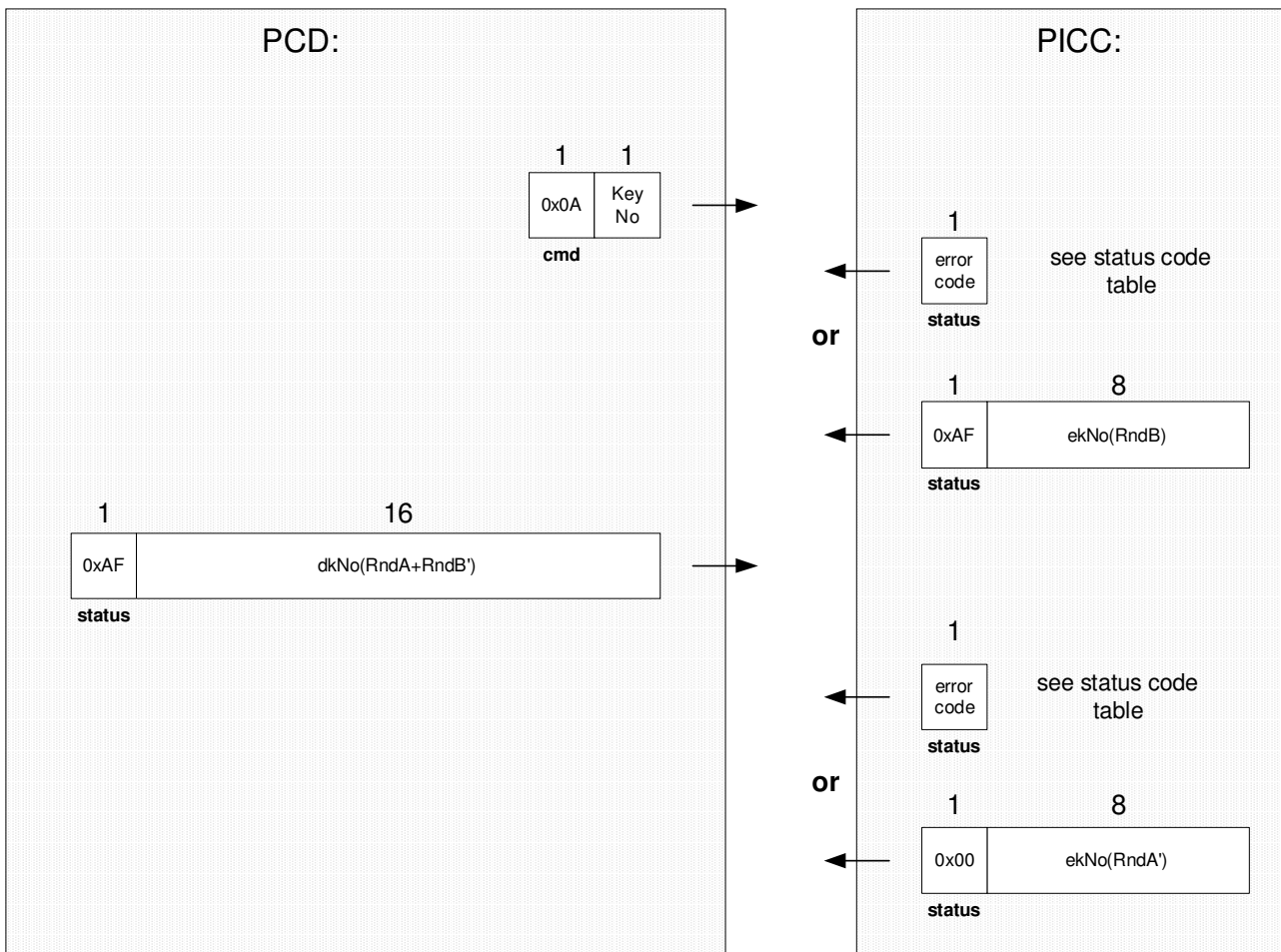

Functional Specification

mifare DESFire MF3 IC D40

Depending on the configuration of the application (represented by its AID), an authentication has to be done to perform specific operations:

- Gather information about the application
- Change the keys of the application
- Create and delete files within the application
- Change access rights
- Access data files in the authenticated application

Depending on the security configuration of the PICC, the following commands may require an authentication with the PICC master keys:

- Gather information about the applications on the PICC
- Change the PICC master key itself
- Change the PICC key settings
- Create a new application
- Delete an existing application

The authentication state is invalidated by

- Selecting an application
- Changing the key which was used for reaching the currently valid authentication status
- A failed authentication

Please note: Master keys are identified by their key number 0x00. This is valid on PICC level (selected AID = 0x00) and on Application level (selected AID ≠ 0x00).

Functional Specification

mifare DESFire MF3 IC D40

4.3.2 ChangeKeySettings

This command changes the master key configuration settings depending on the currently selected AID.

If AID = 0x00 has been selected in advance, the change applies to the PICC key settings, otherwise (AID ≠ 0x00) it applies to the application key settings of the currently selected application.

ChangeKeySettings(KeySettings) [2 bytes]

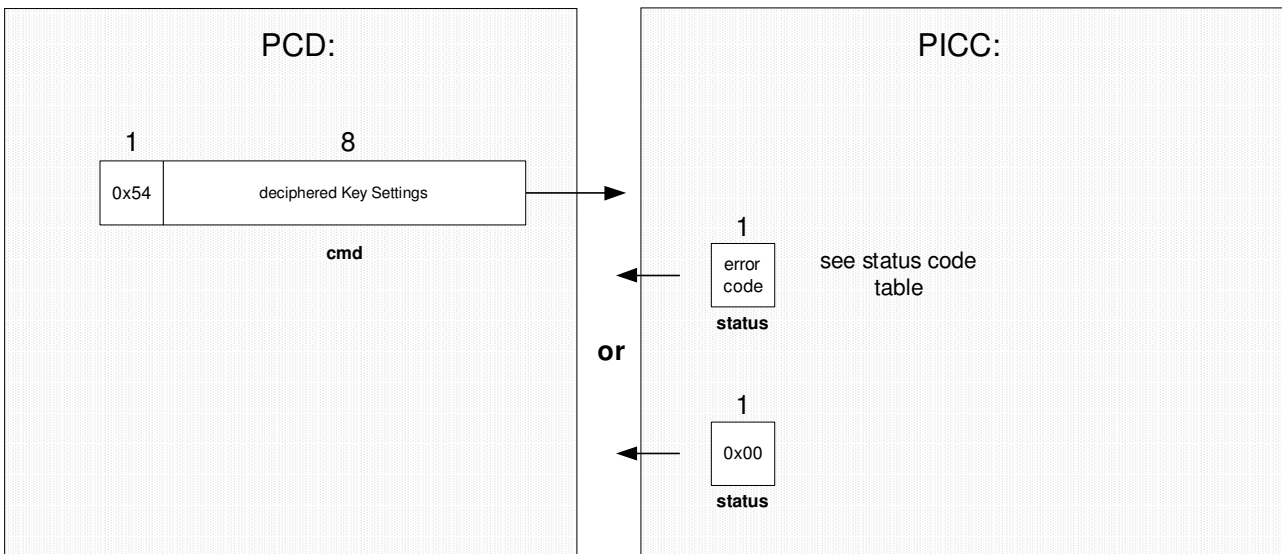

This command only succeeds if the “configuration changeable” bit, see below, of the current key settings was not cleared before.

Additionally a successful preceding authentication with the master key is required (PICC master key if AID = 0x00, else with application master key).

This command takes one byte as parameter which codes the new master key settings.

To guarantee that the ChangeKeySettings command is sent by the same PCD which did the preceding Authentication command, it is necessary to apply the same security mechanism as for the ChangeKey command, see chapter 4.3.4.

A CRC is calculated on the parameter byte and appended at it’s end. As this modified data stream now is of three bytes length, five zero bytes 0x00 are appended to get an 8 bytes long data stream suitable for the DES/3DES decipherment operation.

The PICC now is capable of proving the authenticity of the received data by running a DES/3DES encipherment and checking the recovered CRC and padding bytes of the plain data.

Functional Specification

mifare DESFire MF3 IC D40

- PICC Master Key Settings:

Bit7	Bit6	Bit5	Bit4	Bit3	Bit2	Bit1	Bit0
RFU	RFU	RFU	RFU	configuration changeable	PICC master key not required for create / delete	free directory list access without PICC master key	allow changing the PICC master key

On PICC Level (selected AID = 0x00) the coding is interpreted as:

Bit7-Bit 4: RFU, has to be set to 0.

Bit3: codes whether a change of the PICC master key settings is allowed:

- 0: configuration not changeable anymore (frozen).
- 1: this configuration is changeable if authenticated with PICC master key (default setting).

Bit2: codes whether PICC master key authentication is needed before Create- / DeleteApplication

- 0: CreateApplication / DeleteApplication is permitted only with PICC master key authentication.
- 1: - CreateApplication is permitted without PICC master key authentication (default setting).
- DeleteApplication requires an authentication with PICC master key or application master key*.

Bit1: codes whether PICC master key authentication is needed for application directory access:

- 0: Successful PICC master key authentication is required for executing the GetApplicationIDs and GetKeySettings commands.
- 1: GetApplicationIDs and GetKeySettings commands succeed independently of a preceding PICC master key authentication (default setting).

Bit0: codes whether the PICC master key is changeable:

- 0: PICC Master key is not changeable anymore (frozen).
- 1: PICC Master key is changeable (authentication with the current PICC master key necessary, default setting).

* Note: In case of usage of the application master key for deletion, the application which is about to be deleted needs to be Selected and Authenticated with the application master key prior to the DeleteApplication command.

Functional Specification

mifare DESFire MF3 IC D40

- Application Master Key Settings:

Bit7	Bit6	Bit5	Bit4	Bit3	Bit2	Bit1	Bit0
ChangeKey Access Rights Bit3	ChangeKey Access Rights Bit2	ChangeKey Access Rights Bit1	ChangeKey Access Rights Bit0	configuration changeable	free create / delete without master key	free directory list access without master key	allow change master key

On Application Level (selected AID \neq 0x00) the coding is interpreted as:

Bit7-Bit4: hold the Access Rights for changing application keys (ChangeKey command).

- 0x0: Application master key authentication is necessary to change any key (default).
- 0x1 .. 0xD: Authentication with the specified key is necessary to change any key.
- 0xE: Authentication with the key to be changed (same KeyNo) is necessary to change a key.
- 0xF: All Keys (except application master key, see Bit0) within this application are frozen.

Bit3: codes whether a change of the application master key settings is allowed:

- 0: configuration not changeable anymore (frozen).
- 1: this configuration is changeable if authenticated with the application master key (default setting).

Bit2: codes whether application master key authentication is needed before CreateFile / DeleteFile

- 0: CreateFile / DeleteFile is permitted only with application master key authentication.
- 1: CreateFile / DeleteFile is permitted also without application master key authentication (default setting).

Bit1: codes whether application master key authentication is needed for file directory access:

- 0: Successful application master key authentication is required for executing the GetFileIDs, GetFileSettings and GetKeySettings commands.
- 1: GetFileIDs, GetFileSettings and GetKeySettings commands succeed independently of a preceding application master key authentication (default setting).

Bit0: codes whether the application master key is changeable:

- 0: Application master key is not changeable anymore (frozen).
- 1: Application master key is changeable (authentication with the current application master key necessary, default setting).

Functional Specification

mifare DESFire MF3 IC D40

4.3.3 GetKeySettings

The GetKeySettings command allows to get configuration information on the PICC and application master key configuration settings as described in chapter 4.3.2. In addition it returns the maximum number of keys which can be stored within the selected application.

GetKeySettings() [1 byte]

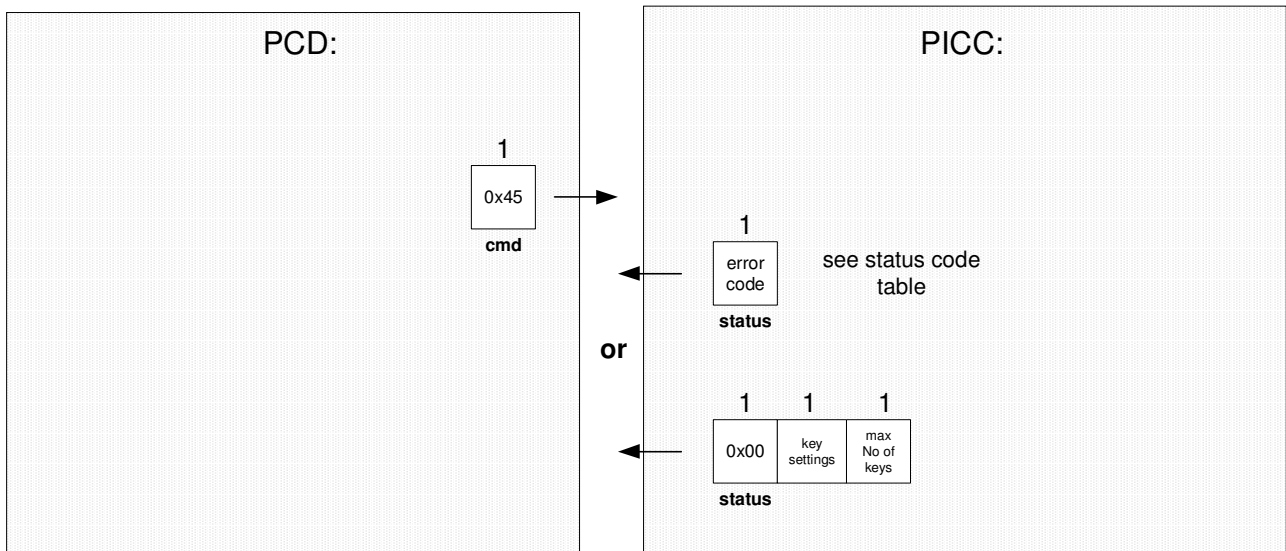

No parameter is passed with this command.

Depending on the master key settings (see chapter 4.3.2), a preceding authentication with the master key is required.

If the PICC master key settings are queried (currently selected AID = 0x00), the number of keys is returned as 0x01, as only one PICC master key exists on a PICC.

Functional Specification

mifare DESFire MF3 IC D40

4.3.4 ChangeKey

This command allows to change any key stored on the PICC.

If AID = 0x00 is selected, the change applies to the PICC master key and therefore only KeyNo = 0x00 is valid (only one PICC master key is present on a PICC). In all other cases (AID ≠ 0x00) the change applies to the specified KeyNo within the currently selected application (represented by it's AID).

ChangeKey(KeyNo) [26 bytes]

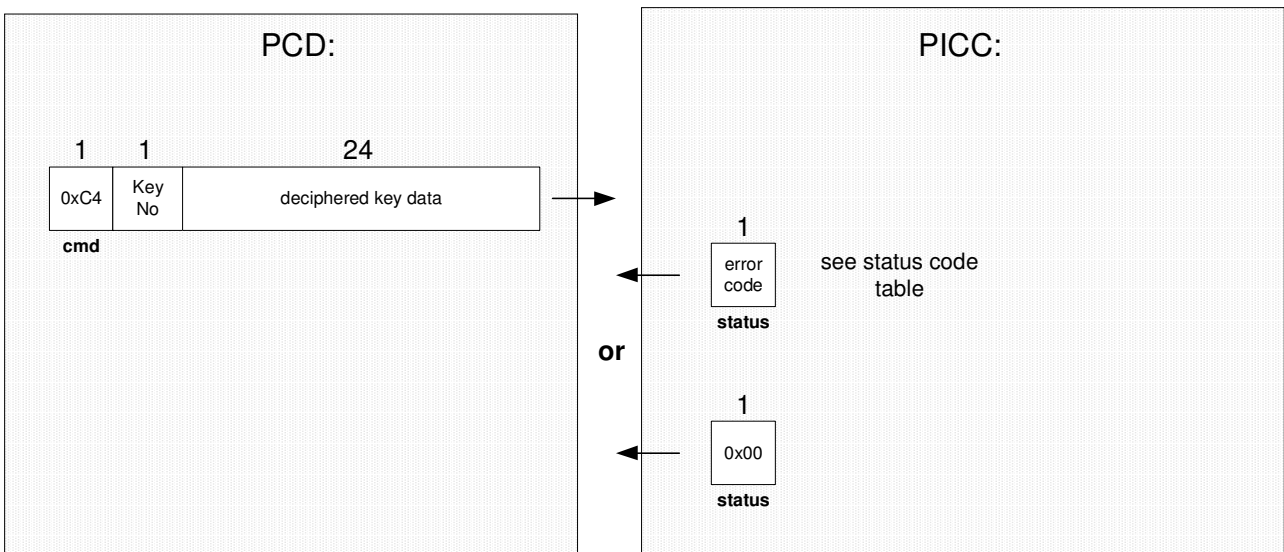

As a parameter this command takes the KeyNo which is of one byte length and has to be in the range from 0x00 to number of application keys - 1.

The second parameter holds the information about the new key packed in a cryptogram.

The respective key settings (see chapter 4.3.2) define whether a change of keys is permitted or not, additionally they show which key is needed for Authentication before the ChangeKey Command.

- To change any key (except Master Key and the ChangeKey Key), authentication with the ChangeKey is necessary.
- To change the ChangeKey Key or the Master Key, authentication with the Master Key is necessary.

Functional Specification

mifare DESFire MF3 IC D40

- In case the KeyNo used for authentication is DIFFERENT from the KeyNo to be changed and ChangeKey Key is set to a value \neq 0xE, the PCD needs to generate the data frame “deciphered key data” in the following way:

The new key and the current key are bit-wise XORed (16 byte). A CRC (2 byte) is calculated over the XORed data and appended at the end. Additionally a CRC (2 byte) of the new key is appended. After this padding of zeros (4 byte) is applied to reach an adequate frame size of multiples of 8 (24 byte overall). Finally a DES/3DES deciphering operation (using the current session key) is performed on the whole key data field. The three cryptogram blocks are chained using the CBC send mode.

- In case the KeyNo used for authentication is the SAME as the KeyNo to be changed or if ChangeKey Key is set to 0xE, the PCD needs to generate the data frame “deciphered key data” in the following way:

A CRC (2 bytes) is calculated over the new key data (16 bytes) and appended at the end. After this padding of zeros (6 bytes) is applied to reach an adequate frame size of multiples of 8 (24 byte overall). Finally a DES/3DES deciphering operation (using the current session key) is performed on the whole key data field. The three cryptogram blocks are chained using the CBC send mode.

- In case the ChangeKey Key is set to 0xF (“never”), all keys except the Master Key (see chapter 4.3.2, Bit0) are frozen. The ChangeKey command therefore will return an error code when attempting to change a key different from the master key.

Note: After a successful change of the key used to reach the current authentication status, this authentication is invalidated i.e. an authentication with the new key is necessary for subsequent operations.

Functional Specification

mifare DESFire MF3 IC D40

4.3.5 GetKeyVersion

The GetKeyVersion command allows to read out the current key version of any key stored on the PICC.

If AID = 0x00 is selected, the command returns the version of the PICC master key and therefore only KeyNo = 0x00 is valid (only one PICC master key is present on a PICC). In all other cases (AID ≠ 0x00) the version of the specified KeyNo within the currently selected application (represented by it's AID) is returned.

GetKeyVersion(KeyNo) [2 bytes]

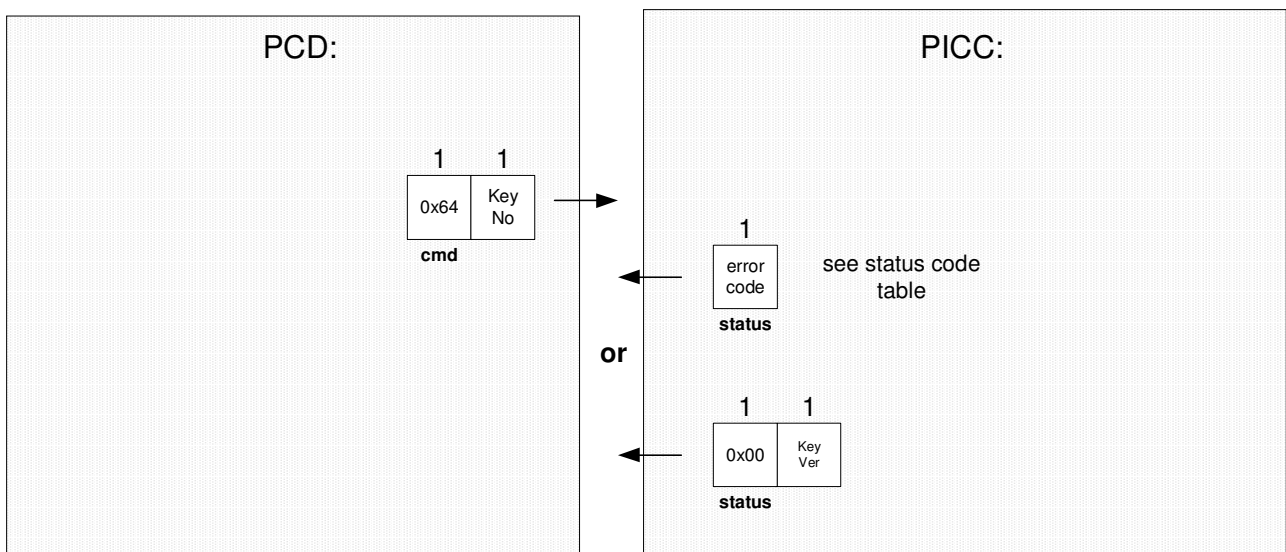

One parameter is passed with this command which codes the key number.

The command returns the current version of the specified key as an unsigned byte.

To change the key version of any key, the ChangeKey command, see chapter 4.3.4, is used.

This command can be issued without valid authentication.

Functional Specification

mifare DESFire MF3 IC D40

4.4 MF3 IC D40 Command Set – PICC Level Commands:

4.4.1 CreateApplication

The CreateApplication command allows to create new applications on the PICC.

CreateApplication(AID,KeySettings,NumOfKeys) [6 bytes]

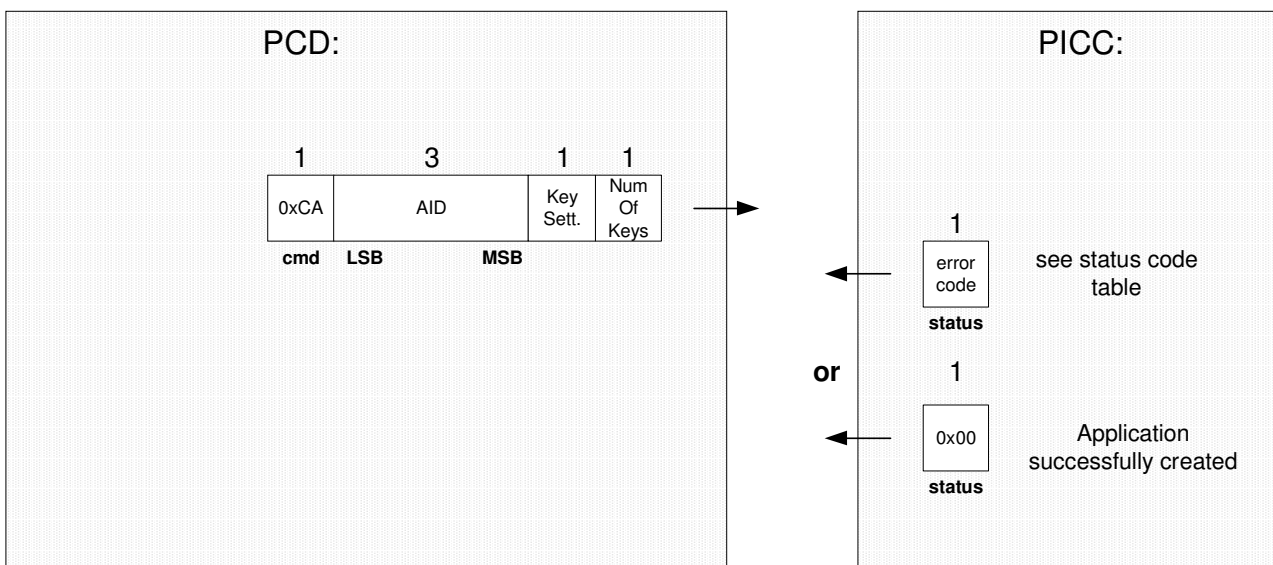

An application is identified by an 'Application Identifier', AID, which is implemented as a 24 bit number. Application Identifier 0x00 00 00 is reserved as a reference to the PICC itself.

Depending on the PICC master key settings, see chapter 4.3.2, a preceding PICC master key authentication may be required.

This command requires that the currently selected AID is 0x00 00 00 which references the card level.

One PICC can hold up to 28 Applications. Each application is linked to a set of up to 14 different user definable access keys. To store data in an application, it is necessary to create so called files within that application, see chapters 4.5.4 to 4.5.8. Up to 16 files of different size and type can be created within each application. Different levels of access rights for each single file can be linked to the keys of the application.

The 24 bit AID is the first parameter of the command.

The second parameter is the Application Master Key Settings as defined in chapter 4.3.2.

The last parameter 'Number of Keys' defines how many keys can be stored within the application for cryptographic purposes.

All keys are initialised with a string consisting of sixteen 0x00 bytes and therefore are single DES keys by definition, see chapter 3.2.

Note: It is **strongly recommended** to personalise the keys latest at card issuing using the command ChangeKey.

Functional Specification

mifare DESFire MF3 IC D40

4.4.2 DeleteApplication

The DeleteApplication command allows to permanently deactivate applications on the PICC.

DeleteApplication(AID) [4 bytes]

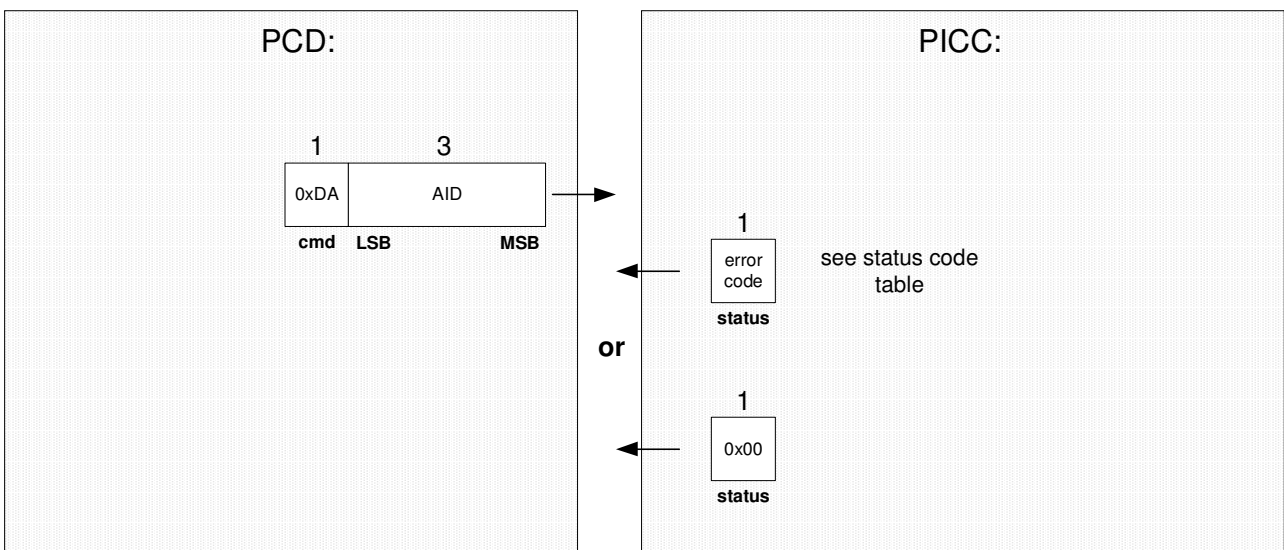

The application which will be deleted is represented by its Application Identifier, AID, which is the only parameter of this command.

Depending on the PICC master key settings, see chapter 4.3.2, either a preceding PICC master key authentication or an application master key authentication is required.

In the latter case, it has to be the master key authentication for the application which shall be deleted by this command.

The AID allocation is removed, therefore it is possible to create a new application with the deleted application's AID. However, the deleted memory blocks can only be recovered by using the FormatPICC command (see chapter 4.4.5) which erases the full user memory of the PICC.

Note: Even if the PICC master key contains the default value 0 and the bit "free create / delete without PICC master key" is set, it is necessary to be either authenticated with the zero PICC master key or the respective application master key.

Note: If the currently selected application is deleted, this command automatically selects the PICC level, selected AID = 0x00 00 00.

Functional Specification

mifare DESFire MF3 IC D40

4.4.3 GetApplicationIDs

The GetApplicationIDs command returns the Application IDentifiers of all active applications on a PICC.

GetApplicationIDs() [1 byte]

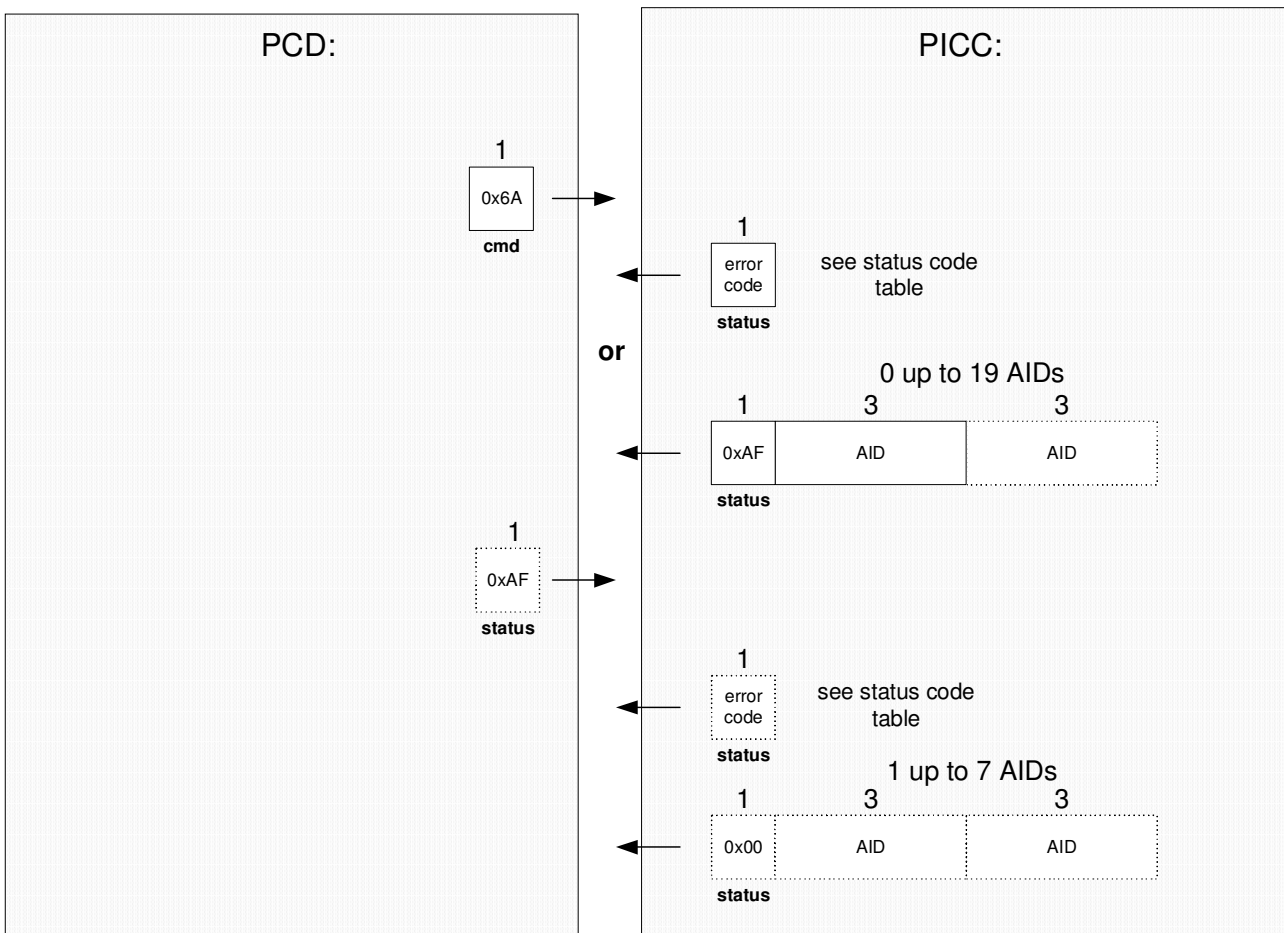

This command does not accept any parameters.

Depending on the PICC master key settings (see chapter 4.3.2) a successful authentication with the PICC master key might be required to execute this command.

This command requires that the currently selected AID is 0x00 00 00 which references the card level.

As response the PICC sends a sequence of all installed AIDs. If this sequence does not fit into one single frame, an additional frame is set by the PICC, indicated by a 0xAF in the status byte of all frames which will be continued.

Functional Specification

mifare DESFire MF3 IC D40

4.4.4 SelectApplication

The SelectApplication command allows to select one specific application for further access.

SelectApplication(AID) [4 bytes]

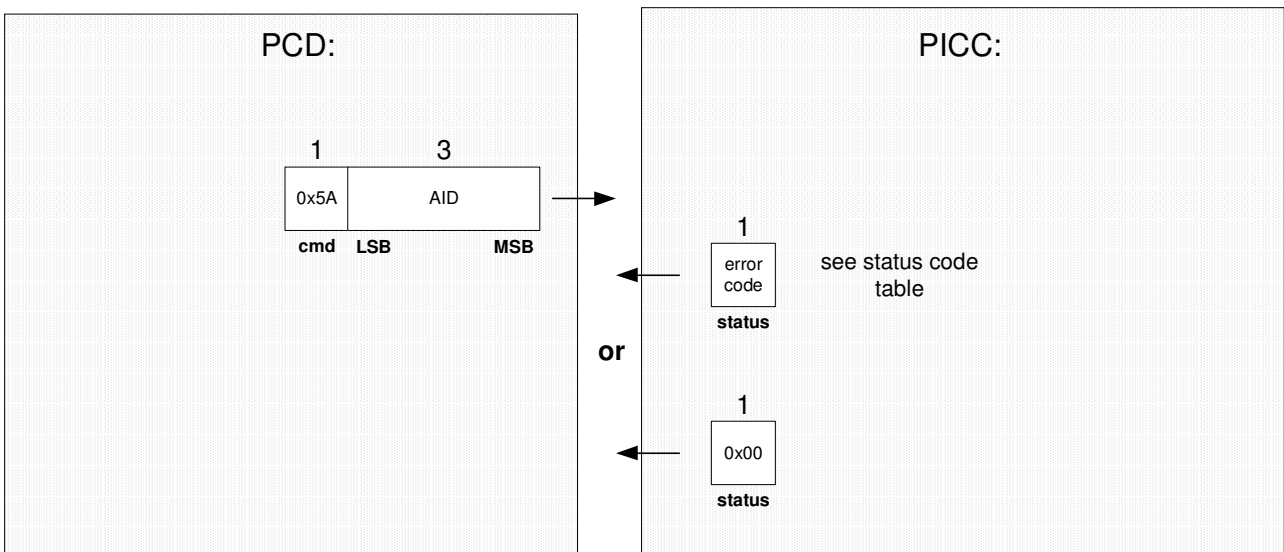

As parameter this command takes three bytes coding the AID.

If this parameter is 0x00 00 00, the PICC level is selected and any further operations (typically commands like CreateApplication, DeleteApplication...) are related to this level.

If an application with the specified AID is found in the application directory of the PICC, the subsequent commands interact with this application.

As mentioned in the description of the Authenticate command (see chapter 4.3.1), each SelectApplication command invalidates the current authentication status.

Functional Specification**mifare DESFire MF3 IC D40**

4.4.5 FormatPICC

This command releases the PICC user memory.

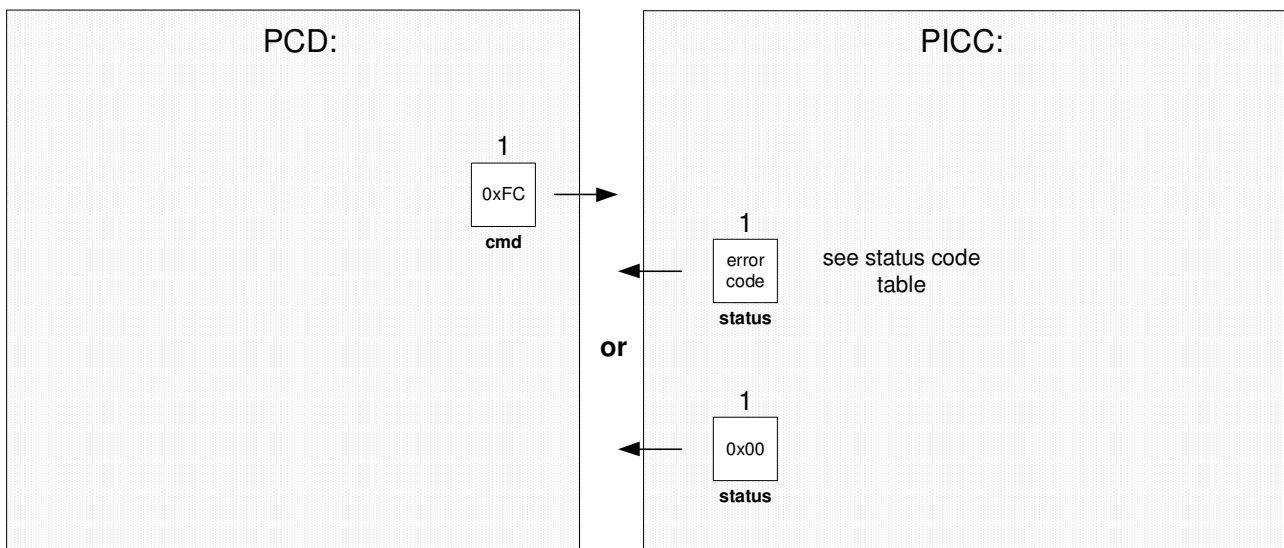
FormatPICC() [1 byte]

No parameters are passed with this command.

The FormatPICC Command releases all allocated user memory on the PICC.

All applications are deleted and all files within those applications are deleted.

The PICC master key and the PICC master key settings keep their currently set values, they are not influenced by this command.

This command always requires a preceding authentication with the PICC master key.

Functional Specification

mifare DESFire MF3 IC D40

4.4.6 GetVersion

The GetVersion command returns manufacturing related data of the PICC.

GetVersion [1 byte]

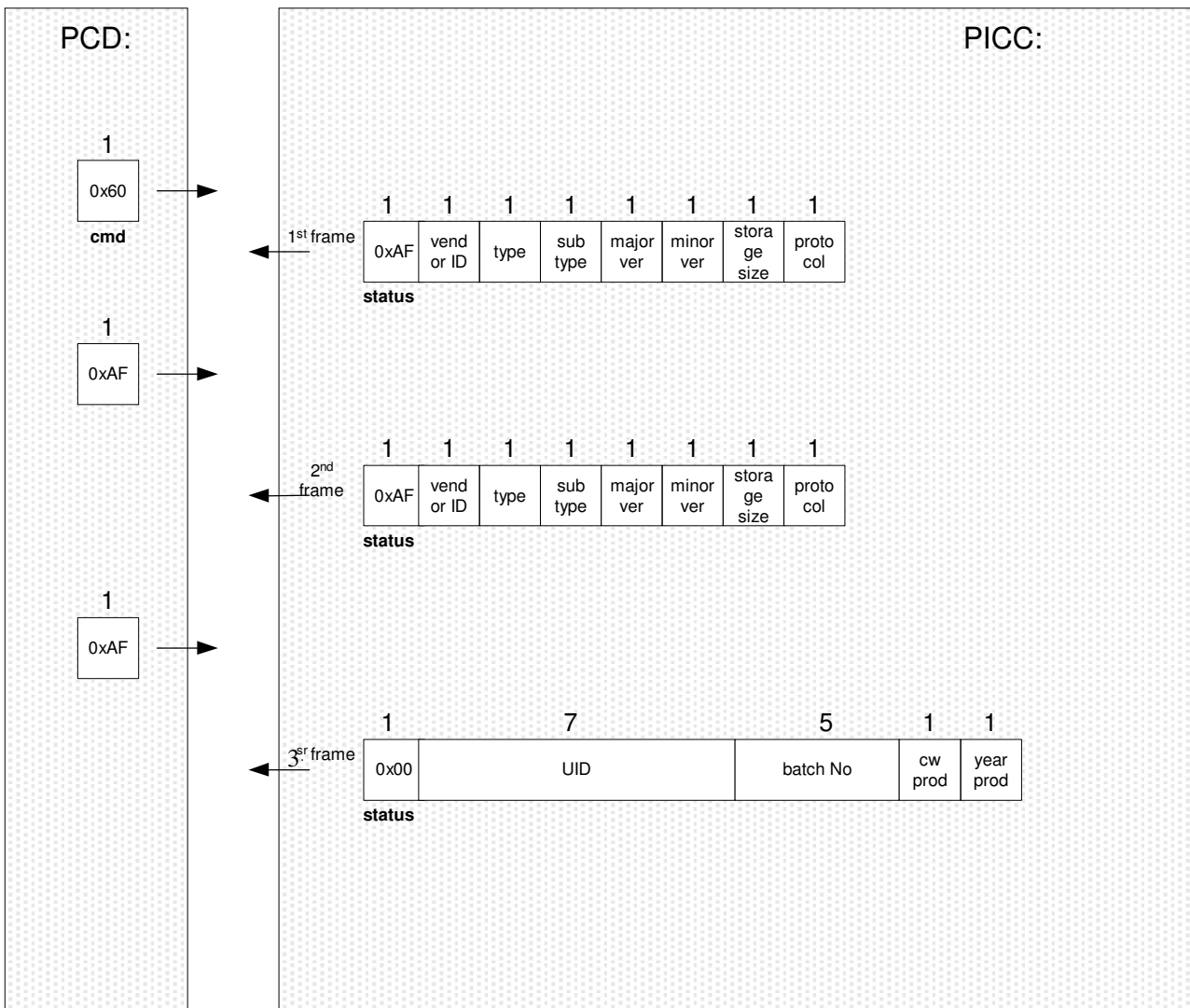

This command takes no parameter.

Functional Specification**mifare DESFire MF3 IC D40**

Three frames of manufacturing related data are returned by the PICC:

The 1st frame: contains hardware related information:

- byte1: codes the vendor ID (0x04 for PHILIPS)
- byte2: codes the type (here 0x01)
- byte3: codes the subtype (here 0x01)
- byte4: codes the major version number
- byte5: codes the minor version number
- byte6: codes the storage size* (here 0x18 = 4096 bytes)
- byte7: codes the communication protocol type (here 0x05 meaning ISO 14443-2 and -3)

The 2nd frame contains software related information:

- byte1: codes the vendor ID (here 0x04 for PHILIPS)
- byte2: codes the type (here 0x01)
- byte3: codes the subtype (here 0x01)
- byte4: codes the major version
- byte5: codes the minor version
- byte6: codes the storage size* (here 0x18 = 4096 bytes)
- byte7: codes the communication protocol type (here 0x05 meaning ISO 14443-3 and -4)

The 3rd frame returns the unique serial number, batch number, year and calendar week of production:

- byte1 to byte7: code the unique serial number
- byte8 to byte12: code the production batch number
- byte13: codes the calendar week of production
- byte14: codes the year of production

* The 7 MSBits (= n) code the storage size itself based on 2^n , the LSBit is set to '0' if the size is exactly 2^n and set to '1' if the storage size is between 2^n and $2^{(n+1)}$. For this version of DESFire the 7 MSBits are set to 0x0C ($2^{12} = 4096$) and the LSBit is '0'.

Functional Specification

mifare DESFire MF3 IC D40

4.5 MF3 IC D40 Command Set – Application Level Commands:

The MF3 IC D40 provides the following command set for Application level functions:

4.5.1 GetFileIDs

The GetFileIDs command returns the File IDentifiers of all active files within the currently selected application.

GetFileIDs() [1 byte]

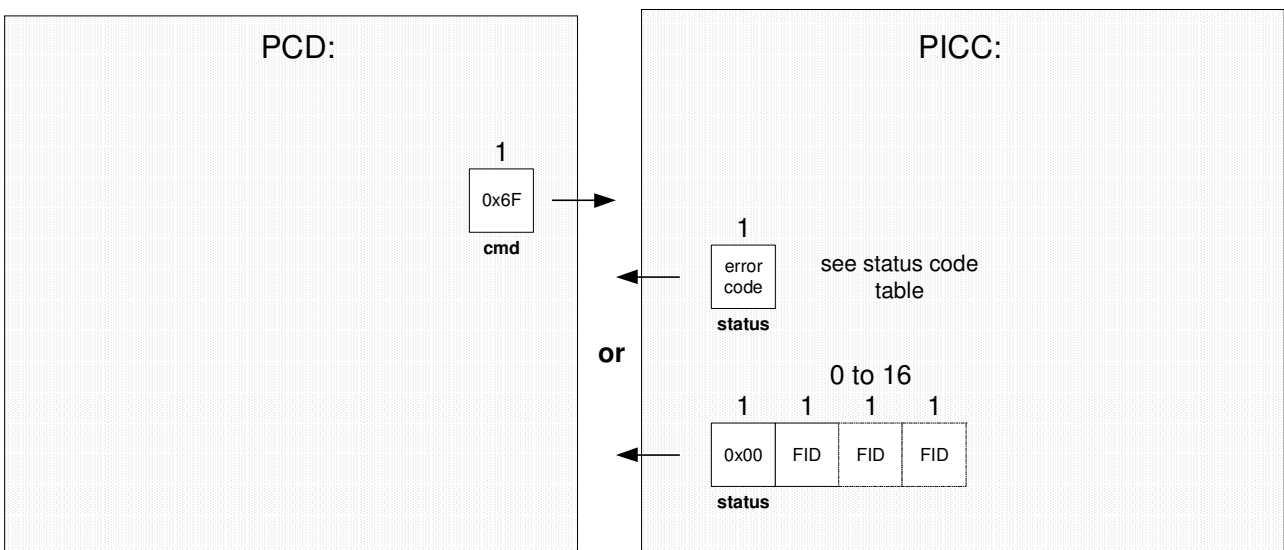

This command takes no parameters.

Depending on the application master key settings (see chapter 4.3.2), a preceding authentication with the application master key might be required.

Each File ID is coded in one byte and is in the range from 0x00 to 0x0F.

Duplicate values are not possible as each file must have an unambiguous identifier.

As the number of files is limited to sixteen within one application, the response always fits into one single data frame.

Functional Specification

mifare DESFire MF3 IC D40

4.5.2 GetFileSettings

The GetFileSettings command allows to get information on the properties of a specific file. The information provided by this command depends on the type of the file which is queried.

GetFileSettings() [2 byte]

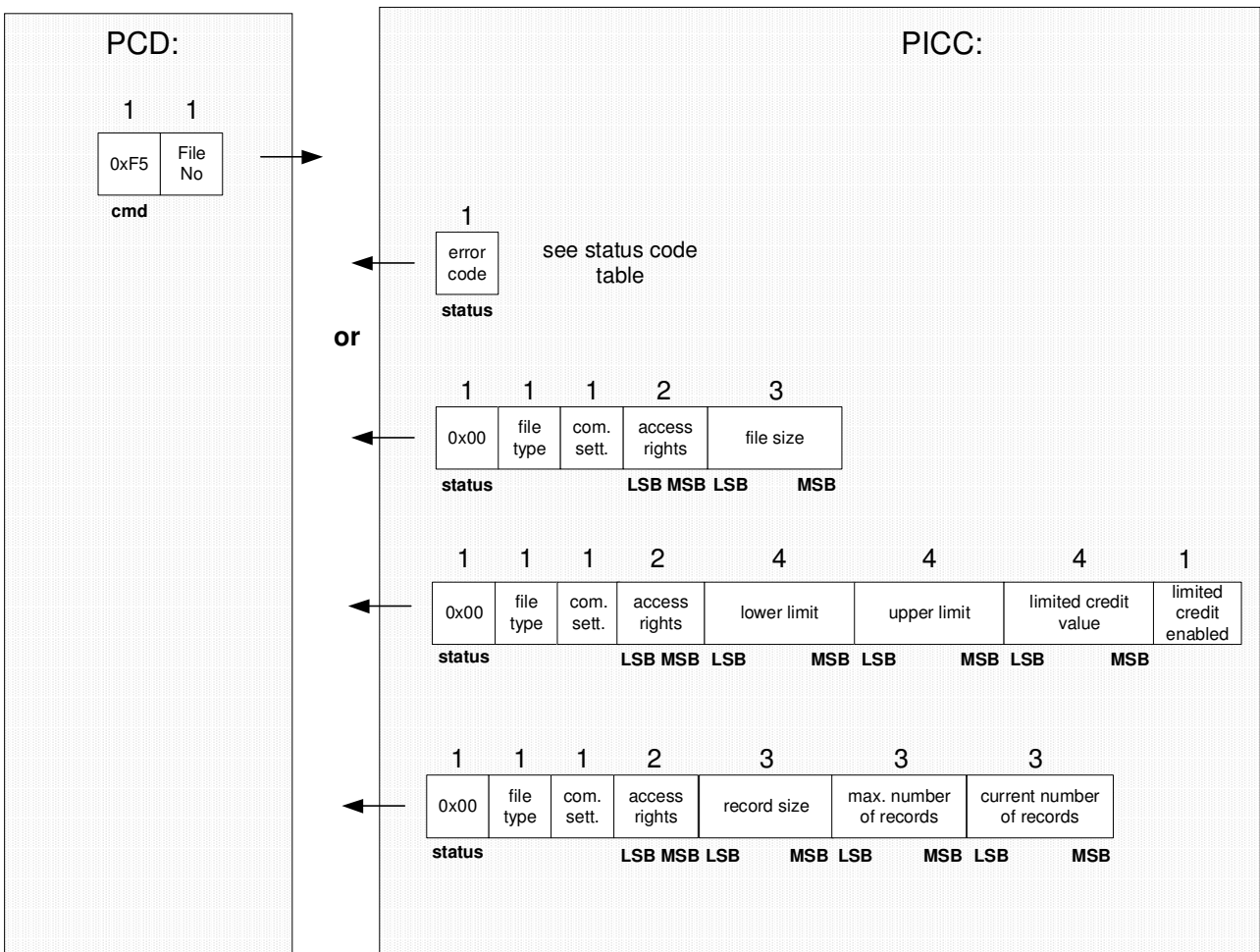

The GetFileSettings command takes one parameter, coding the file number of the file to be queried within the currently selected application. This file number must be in the range between 0x00 and 0x0F.

Depending on the application master key settings (see chapter 4.3.2), a preceding authentication with the application master key might be required.

After updating a value file's value but before issuing the CommitTransaction command, the GetFileSettings command will always retrieve the old, unchanged limit for the limited credit value.

Functional Specification

mifare DESFire MF3 IC D40

The first part of the returned message is the same for all file types:

The first byte indicates the file's type, see chapter 3.1.

The next byte provides information on the file's communication settings (plain/MACed/Enciphered), see chapter 3.2.

This information is followed by the 2 byte file Access Rights field, see chapter 3.3.

All subsequent bytes in the response have a special meaning depending on the file type:

- Standard Data Files and Backup Data Files:

One field of three bytes length returns the user file size in bytes.

- Value Files:

Three fields, each of four bytes length, are returned whereby the first field returns the "lower limit" of the file (as defined at file creation), the second field returns the "upper limit" (as defined at file creation) and the next field returns the current maximum "limited credit" value, see chapter 4.6.5. If the limited credit functionality is not in use, the last field contains all zeros. The last byte codes, if the LimitedCredit command is allowed for this file (0x00 for disabled, 0x01 for enabled).

- Linear Record Files and Cyclic Record Files:

Three fields, each of three bytes length, are returned whereby the first field codes the size of one single record (as defined at file creation), the second field codes the maximum number of records within the record file (as defined at file creation) and the last field returns the current number of records within the record file. This number equals the maximum number of records which currently can be read, see chapter 4.6.8.

Functional Specification

mifare DESFire MF3 IC D40

4.5.3 ChangeFileSettings

This command changes the access parameters of an existing file.

ChangeFileSettings(FileNo,Com.Set.,AccessRights) [5/10 bytes]

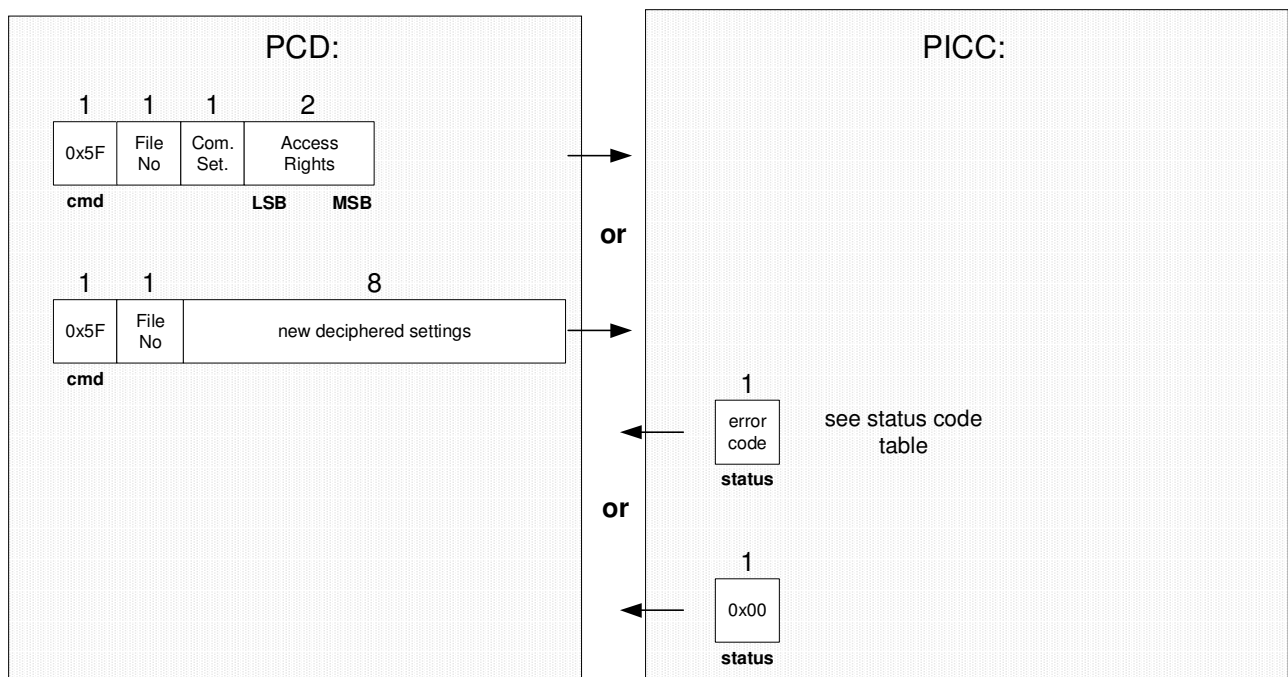

As first parameter one byte is to be passed which codes the file number within the currently selected application.

The next byte defines the new communication settings, see chapter 3.2.

Finally a two byte field defines the new Access Rights, see chapter 3.3.

This change only succeeds if the current Access Rights for “Change Access Rights” is different from “never”, see also chapter 3.3.

To guarantee that the ChangeFileSettings command is coming from the same party which did the preceding authentication, it is necessary to apply basically the same security mechanism as used with the ChangeKey command, see chapter 4.3.4:

A CRC is calculated over the new three byte settings and appended at the end. As this modified data stream now is of five bytes length, three bytes, all 0x00, are appended to get an eight bytes long data stream suitable for DES/3DES operation. Finally a DES/3DES decipherment is done on this data on PCD side.

The PICC now is capable of proving the authenticity of the received data by running a DES/3DES encipherment and checking the recovered CRC on the plain data.

However, if the ChangeAccessRights Access Rights is set with the value “free”, no security mechanism is necessary and therefore the data is sent as plain text (5 byte overall length).

Functional Specification

mifare DESFire MF3 IC D40

4.5.4 CreateStdDataFile

The CreateStdDataFile command is used to create files for the storage of plain unformatted user data within an existing application on the PICC.

CreateStdDataFile(FileNo,Com.Set.,AccessRights,FileSize)
[8bytes]

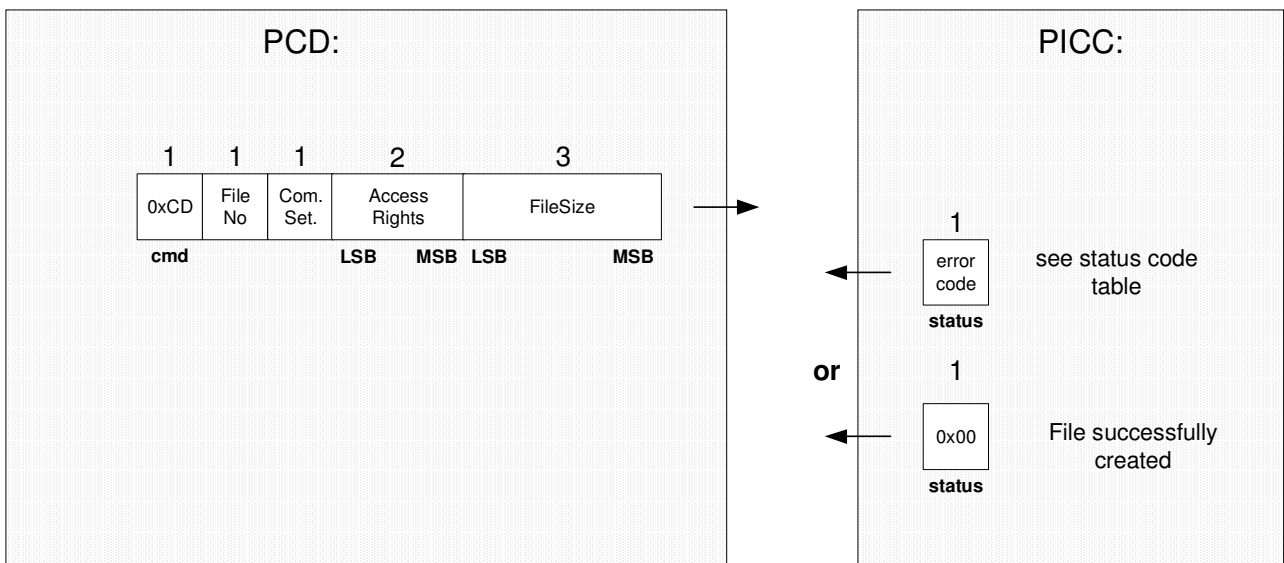

As first parameter this command needs the file number of the new file within the range 0x00 to 0x0F. The file will be created in the currently selected application. It is not necessary to create the files within the application in a special order. If a file with the specified number already exists within the currently selected application, an error code is returned.

The next byte defines the communication settings, see chapter 3.2.

Then a two byte field defines the Access Rights for the new file, see chapter 3.3.

The last parameter of three byte length specifies the size of the file in bytes.

Note: The MF3 IC D40 internally allocates NV-memory in multiples of 32 bytes. Therefore a file creation command with FileSize parameter 0x00 00 01 (1 byte file size) will internally consume the same amount of NV-memory as a 0x00 00 20 (32 byte file size), namely 32 bytes.

Functional Specification

mifare DESFire MF3 IC D40

4.5.5 CreateBackupDataFile

The CreateBackupDataFile command is used to create files for the storage of plain unformatted user data within an existing application on the PICC, additionally supporting the feature of an integrated backup mechanism.

CreateBackupDataFile(FileNo,Com.Set.,AccessRights,FileSize)
[8bytes]

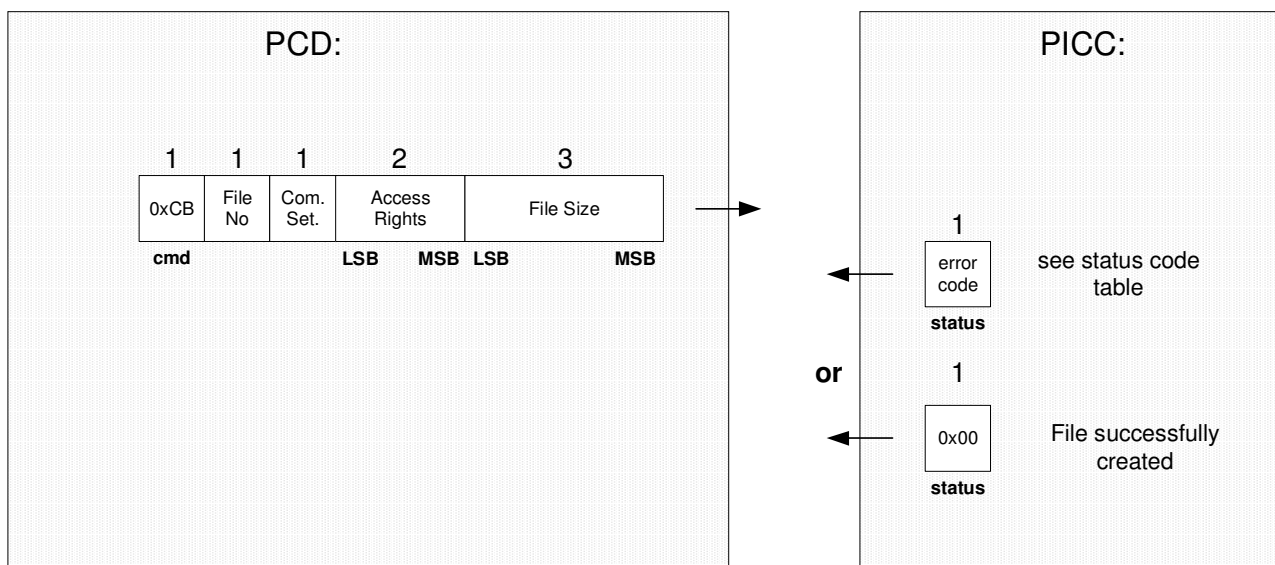

As the name “BackupDataFile” implies, files of this type feature an integrated backup mechanism.

Every Write command is done in a independent mirror image of this file. To validate a write access to this file type, it is necessary to confirm it with a CommitTransaction command, see chapter 4.6.10. If no CommitTransaction command is send by the PCD, only the mirror image is changed, the original data remains unchanged and valid.

All parameters have the same format as for the CreateStdDataFile command, see chapter 4.5.4, except the parameter FileNo. As only the first 8 files within an application feature the integrated backup mechanism, only FileNo 0x00 to 0x07 is allowed.

Due to the mirror image a BackupDataFile always consumes DOUBLE the NV-memory on the PICC compared to a StdDataFile with the same specified FileSize.

Functional Specification

mifare DESFire MF3 IC D40

4.5.6 CreateValueFile

The CreateValueFile command is used to create files for the storage and manipulation of 32bit signed integer values within an existing application on the PICC.

**CreateValueFile(FileNo,Com.Set.,AccessRights,LowerLimit,
UpperLimit,Value,LimitedCreditEnabled)
[18 bytes]**

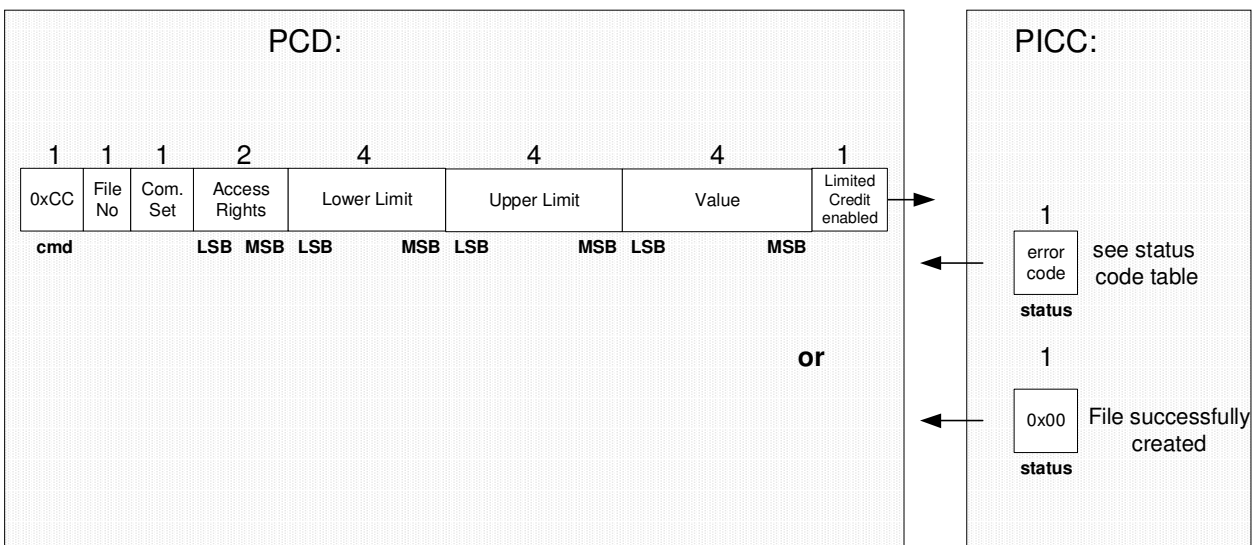

As first parameter one byte codes the file number in the range 0x00 to 0x07 which the new created file should get within the currently selected application.

The next byte defines the communication settings, see chapter 3.2

Then a two byte field defines the Access Rights for the new file, see chapter 3.3.

The next parameter is of 4 byte length and codes the lower limit which is valid for this file. The lower limit marks the boundary which must not be passed by a Debit calculation on the current value, see chapter 4.6.5. The lower limit is a 4 byte signed integer and thus may be negative too.

After this again 4 bytes are used to code the upper limit which sets the boundary in the same manner but for the Credit operation, see chapter 4.6.4. This parameter is also a 4 byte signed integer.

The upper limit has to be \geq lower limit, otherwise an error message would be sent by the PICC and thus the file would not be created.

The next parameter is a 4 byte signed integer again and specifies the initial value of the value file. The upper and lower limit is checked by the PICC, in case of inconsistency the file is not created and an error message is sent by the PICC.

The last bytes codes the activation of the LimitedCredit feature, see chapter 4.6.6. Here 0x00 means that LimitedCredit is disabled and 0x01 enables this feature.

ValueFiles feature always the integrated backup mechanism. Therefore every access changing the value needs to be validated using the CommitTransaction command, see chapter 4.6.10.

Functional Specification

mifare DESFire MF3 IC D40

4.5.7 CreateLinearRecordFile

The CreateLinearRecordFile command is used to create files for multiple storage of structural data, for example for loyalty programs, within an existing application on the PICC. Once the file is filled completely with data records, further writing to the file is not possible unless it is cleared, see command ClearRecordFile, chapter 4.6.9.

CreateLinearRecordFile(FileNo,Com.Set.,AccessRights,Rec.Size, MaxNumOfRecords) [11 bytes]

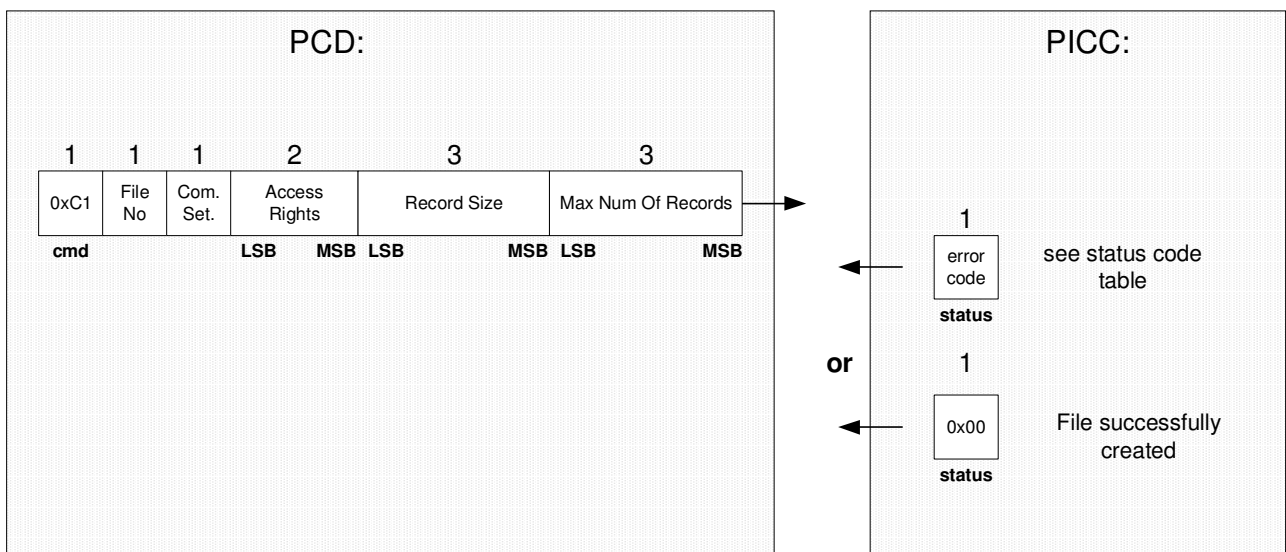

As first parameter one byte codes the file number in the range 0x00 to 0x07 which the new created file should get within the currently selected application.

The next byte defines the communication settings, see chapter 3.2.

Then a two byte field defines the Access Rights for the new file, see chapter 3.3.

The next parameter is of three bytes length and codes the size of one single record in bytes. This parameter has to be in the range from 0x00 00 01 to 0xFF FF FF.

The last parameter is also of three bytes length and codes the number of records. This parameter has to be in the range from 0x00 00 01 to 0xFF FF FF, too.

Thus the entire file size in the PICC NV-memory is given by RecordSize*MaxNumOfRecords.

Linear Record Files feature always the integrated backup mechanism. Therefore every access appending a record needs to be validated using the CommitTransaction command, see chapter 4.6.10.

Functional Specification

mifare DESFire MF3 IC D40

4.5.8 CreateCyclicRecordFile

The CreateCyclicRecordFile command is used to create files for multiple storage of structural data, for example for logging transactions, within an existing application on the PICC. Once the file is filled completely with data records, the PICC automatically overwrites the oldest record with the latest written one. This wrap is fully transparent for the PCD.

CreateCyclicRecordFile(FileNo,Com.Set.,AccessRights,Rec.Size,MaxNumOfRecords) [11 bytes]

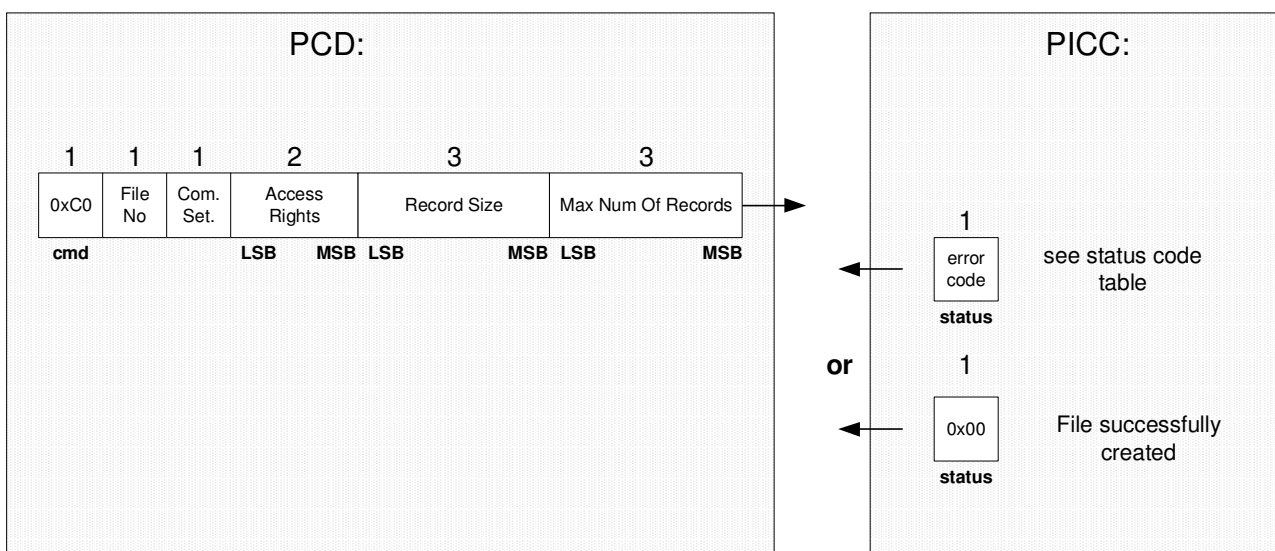

As first parameter one byte codes the file number in the range 0x00 to 0x07 which the new created file should get within the currently selected application.

The next byte defines the communication settings, see chapter 3.2.

Then a two byte field defines the Access Rights for the new file, see chapter 3.3.

The next parameter is of three bytes length and codes the size of one single record in bytes. This parameter has to be in the range from 0x00 00 01 to 0xFF FF FF.

The last parameter is also of three bytes length and codes the number of records. This parameter has to be in the range from 0x00 00 02 to 0xFF FF FF, too.

Thus the entire file size in the PICC NV-memory is given by RecordSize*MaxNumOfRecords.

Cyclic Record Files feature always the integrated backup mechanism. Therefore every access appending a record needs to be validated using the CommitTransaction command, see chapter 4.6.10.

Note: as the backup feature consumes one record, the 'Max. Num Of Records' needs to be one larger than the application requires.

Functional Specification

mifare DESFire MF3 IC D40

4.5.9 DeleteFile

The DeleteFile command permanently deactivates a file within the file directory of the currently selected application.

DeleteFile(FileNo) [2 bytes]

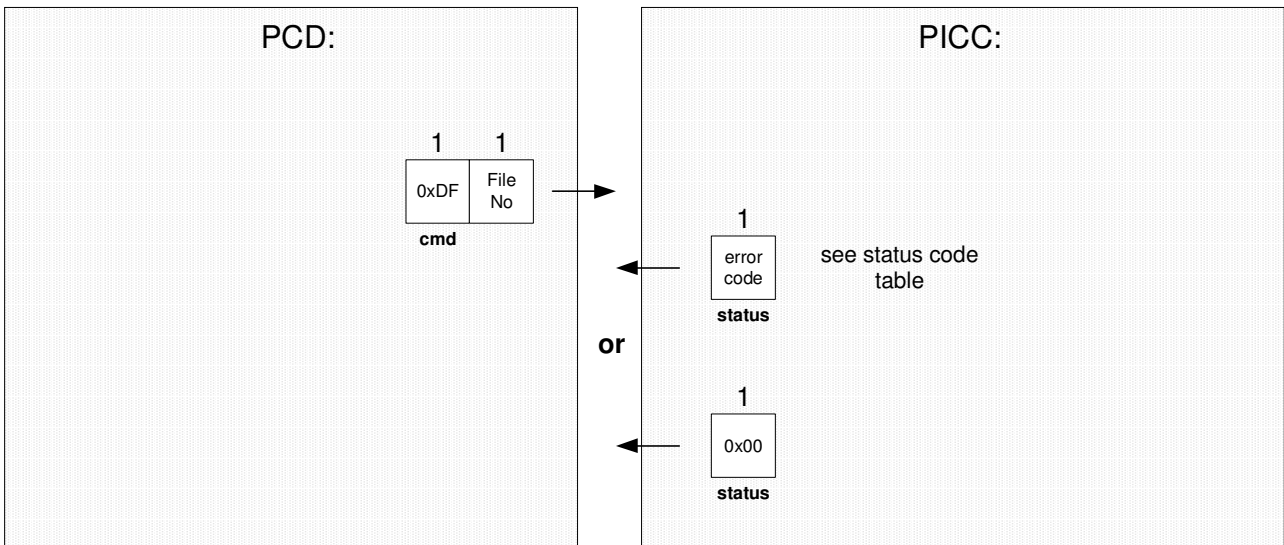

This command takes one byte as parameter coding the file number which is to be in the range from 0x00 to 0x0F

The operation of this command invalidates the file directory entry of the specified file which means that the file can't be accessed anymore.

Depending on the application master key settings, see chapter 4.3.2, a preceding authentication with the application master key is required.

Allocated memory blocks associated with the deleted file are not set free. The FileNo of the deleted file can be re-used to create a new file within that application.

To release memory blocks for re-use, the whole PICC user NV-memory needs to be erased using the FormatPICC command, see chapter 4.4.5.

Functional Specification

mifare DESFire MF3 IC D40

4.6 MF3 IC D40 Command Set – Data Manipulation Commands

The MF3 IC D40 provides the following command set for Data Manipulation:

4.6.1 ReadData

The ReadData command allows to read data from Standard Data Files or Backup Data Files.

ReadData(FileNo,Offset,Length) [8bytes]

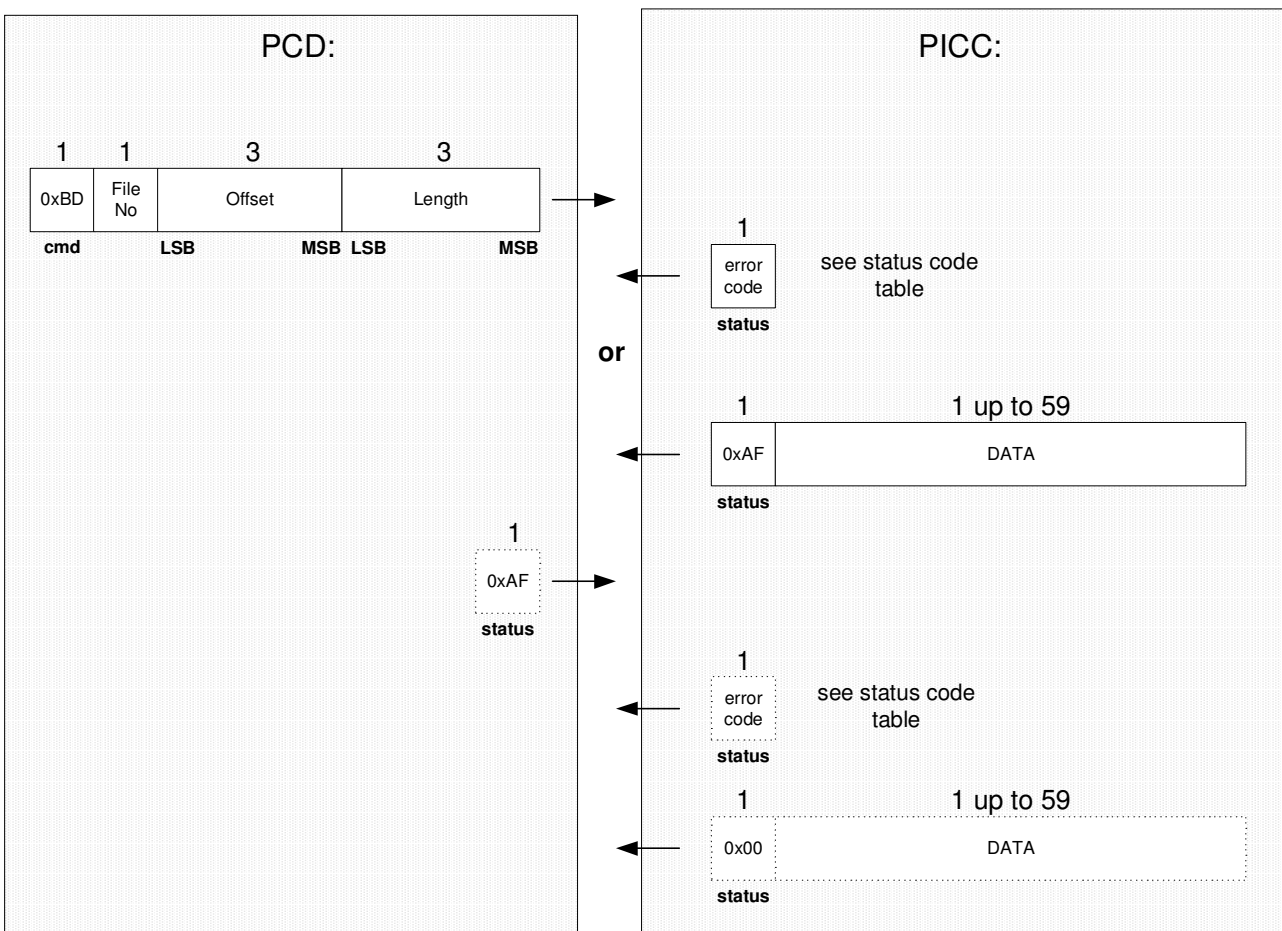

The first parameter is of 1 byte length and defines the file number to be read from. This parameter has to be in the range from 0x00 to 0x0F for Standard Data Files and 0x00 to 0x07 for Backup Data Files, respectively.

The next parameter is of three byte length and codes the starting position for the read operation within the file (= offset value). This parameter has to be in the range from 0x00 00 00 to file size -1.

The third parameter is also three byte long and specifies the number of data bytes to be read. This parameter can be in the range from 0x00 00 00 to 0xFF FF FF.

If the third parameter is coded as 0x00 00 00, the entire data file, starting from the position specified in the offset value, is read.

Functional Specification

mifare DESFire MF3 IC D40

If the number of bytes to send to the PCD does not fit into one single frame, the PICC waits for a status frame with status byte 0xAF, before the next frame is sent to the PCD.

If Backup Data Files are read after writing to them, but before issuing the CommitTransaction command, see chapter 4.6.10, the ReadData command will always retrieve the old, unchanged data stored in the PICC. All data written to a Backup Data File is validated and externally "visible" for a ReadData command only after a CommitTransaction command.

The Read command requires a preceding authentication either with the key specified for "Read" or "Read&Write" access, see chapter 3.3.

Depending on the communication settings, see chapter 3.2, linked to the file, data will be sent by the PICC either plain, MACed or enciphered. All cryptographic operations are done in CBC mode.

For MACed- and enciphered communication padding on the data is necessary to reach an overall data-length of multiples of eight. In case of a specified data length (command parameter Length \neq 0x00 00 00) padding is done with all 0x00.

Only in case enciphered communication AND the file is read until it's limit (command parameter Length = 0x00 00 00), the first byte appended for padding is 0x80, all other bytes appended are 0x00 (in accordance with ISO 9797-1).

NOTE: In case of MACing the padding bytes are only used for cryptographic purpose but NOT exchanged between PCD and PICC.

Functional Specification

mifare DESFire MF3 IC D40

4.6.2 WriteData

The WriteData command allows to write data to Standard Data Files and Backup Data Files.

WriteData(FileNo,Offset,Length,Data) [8+bytes]

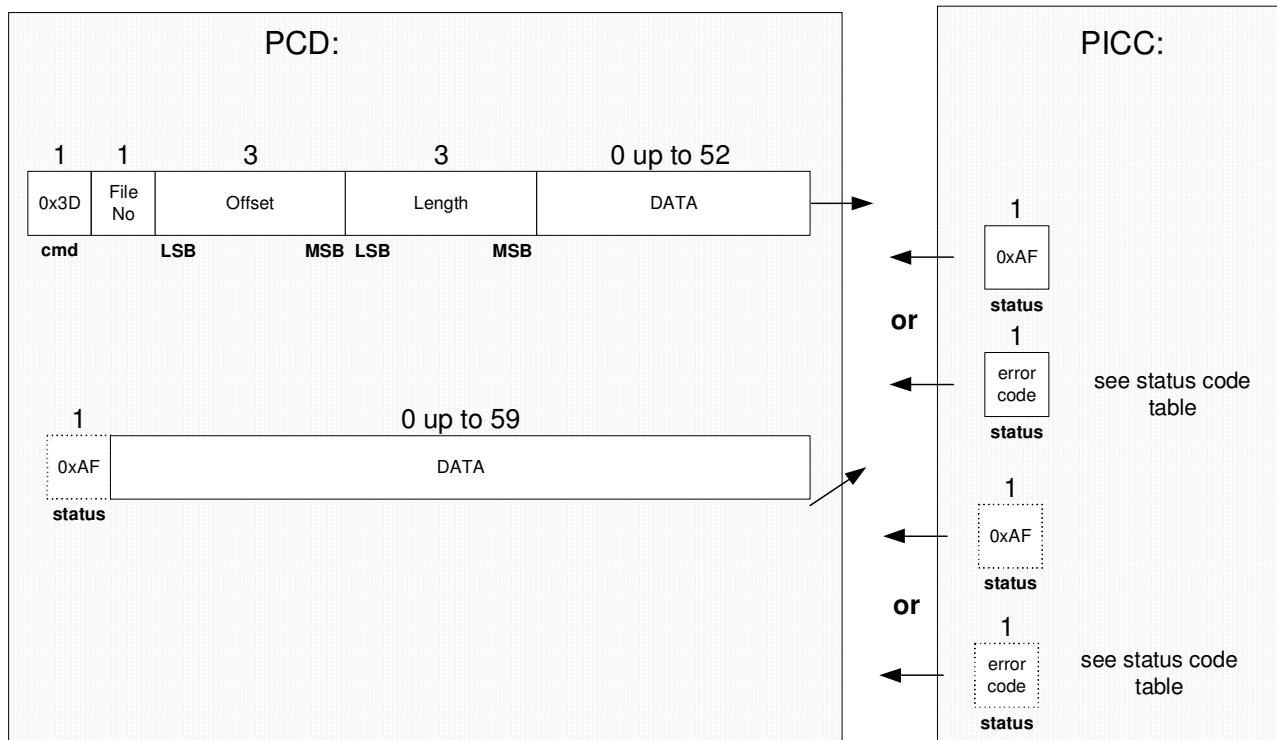

The first parameter is of 1 byte length and defines the file number to be written to; valid range is 0x00 to 0x0F for Standard Data Files and 0x00 to 0x07 for Backup Data Files, respectively.

The next parameter is of three bytes length and codes the starting position for the write operation within the file (= offset value). This parameter has to be in the range from 0x00 00 00 to file size -1.

The third parameter is also three bytes long and specifies the number of data bytes to be written. This parameter can be in the range from 0x00 00 01 to 0xFF FF FF.

If the number of bytes to send does not fit into one single frame, the PCD has to wait for a status frame with status byte 0xAF before sending the next frame to the PICC.

The Write command requires a preceding authentication either with the key specified for "Write" or "Read&Write" access, see chapter 3.3.

Depending on the communication settings, see chapter 3.2, linked to the file, data needs to be sent by the PCD either plain, MACed or enciphered. All cryptographic operations are done in CBC mode.

For MACed and enciphered communication padding of the data string is necessary to reach an overall data-length of multiples of eight. This padding is done with all 0x00.

If the WriteData operation is performed on a Backup Data File, it is necessary to validate the written data with a CommitTransaction command, see chapter 4.6.10. An AbortTransaction command will invalidate all changes, see chapter 4.6.11.

Functional Specification

mifare *DESFire* MF3 IC D40

If data is written to Standard Data Files (without integrated backup mechanism), data is directly programmed into the visible NV-memory of the file. The new data is immediately available to any following ReadData commands performed on that file.

Note: In case of MACed or enciphered communication the validity of data is verified by the PICC by checking the MAC or the CRC (including necessary padding bytes) which is transmitted at the end of the data frame. If the verification fails (MAC / CRC does not fit data, padding bytes invalid), the PICC stops further NV-programming and returns an Integrity Error to the PCD, see chapter 3.4. As a consequence of the Integrity Error any transaction, which might have begun, is automatically aborted.

Note: Getting an Integrity Error when writing on a Standard Data File can corrupt the content of the file.

Note: In case of MACing the padding bytes are only used for cryptographic purpose but NOT exchanged between PCD and PICC.

Functional Specification

mifare DESFire MF3 IC D40

4.6.3 GetValue

The GetValue command allows to read the currently stored value from Value Files.

GetValue(FileNo) [2 bytes]

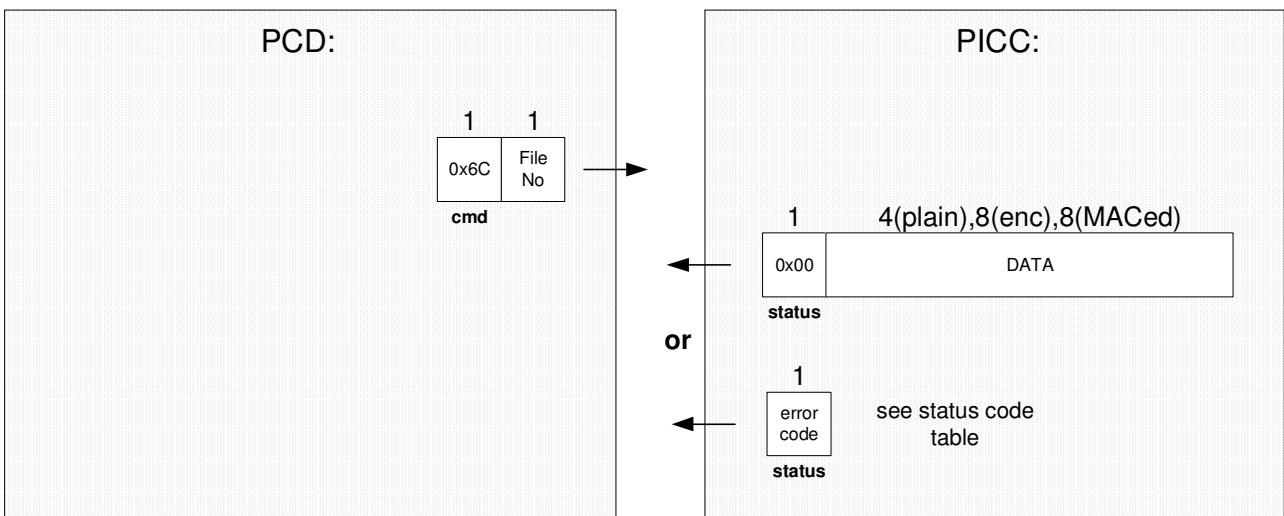

The only parameter sent with this command is of one byte length and codes the file number. This parameter has to be in the range from 0x00 to 0x07.

The PICC response holds the current value of the Value file. Depending on the communication mode data is either transferred plain (4 bytes), enciphered (8 bytes enciphered data: 4 bytes value, 2 bytes CRC, 2 bytes padding with 0x00) or MACed (4 bytes value + 4 bytes MAC).

The value is always represented LSB first.

The GetValue command requires a preceding authentication with the key specified for Read, Write or Read&Write access, see chapter 3.3.

After updating a value file's value but before issuing the CommitTransaction command, the GetValue command will always retrieve the old, unchanged value which is still the valid one.

Functional Specification

mifare DESFire MF3 IC D40

4.6.4 Credit

The Credit command allows to increase a value stored in a Value File.

Credit(FileNo,Data) [6/10 bytes]

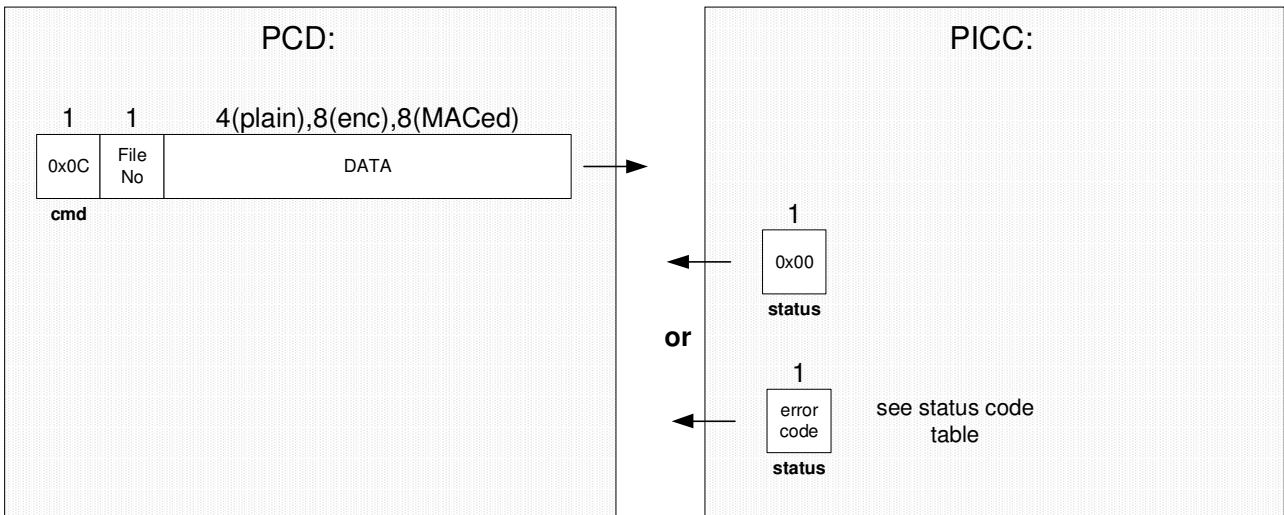

The first parameter sent with this command is of one byte length and codes the file number. This parameter has to be in the range from 0x00 to 0x07.

This command increases the current value stored in the file by a certain amount (4 byte signed integer) which is transmitted in the data field. Only positive values are allowed for the Credit command.

Depending on the communication mode the value is either transferred plain (4 bytes), enciphered (8 bytes enciphered data: 4 bytes value, 2 bytes CRC, 2 bytes padding with 0x00) or MACed (4 bytes value + 4 bytes MAC).

The value is always represented LSB first.

It is necessary to validate the updated value with a CommitTransaction command, see chapter 4.6.10. An AbortTransaction command will invalidate all changes, see chapter 4.6.11.

The value modifications of Credit, Debit and LimitedCredit commands are cumulated until a CommitTransaction command is issued.

Credit commands do NEVER modify the Limited Credit Value of a Value file. However, if the Limited Credit Value needs to be set to 0, a LimitedCredit with value 0 can be used.

The Credit command requires a preceding authentication with the key specified for "Read&Write" access, see chapter 3.3.

Functional Specification

mifare DESFire MF3 IC D40

4.6.5 Debit

The Debit command allows to decrease a value stored in a Value File.

Debit(FileNo,Data) [6/10 bytes]

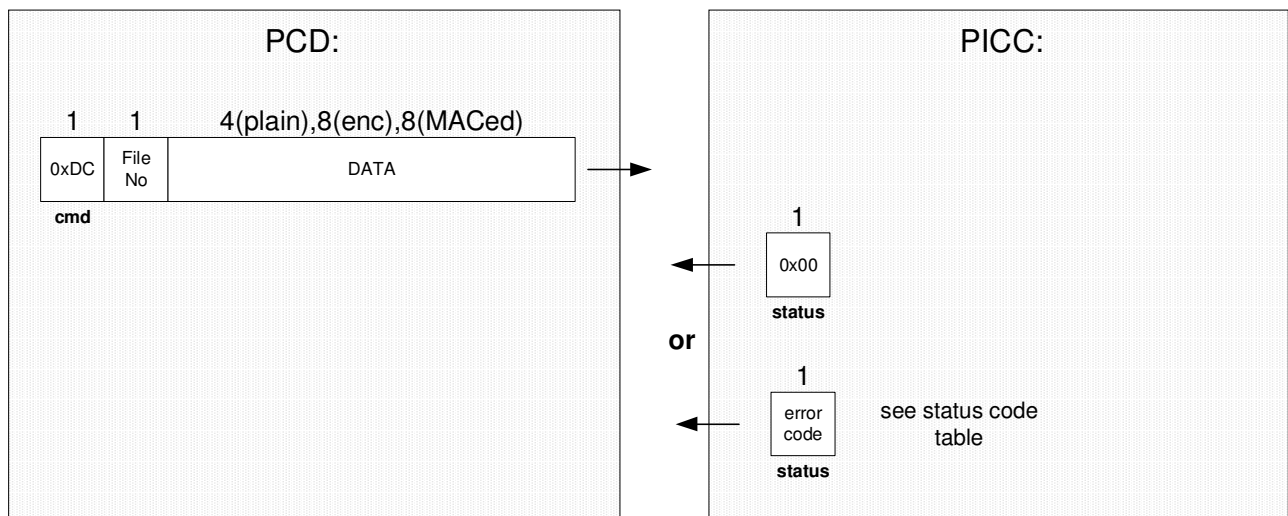

The first parameter is of one byte length and codes the file number. This parameter has to be in the range from 0x00 to 0x07.

The next parameter (4 byte signed integer) holds the value which will be subtracted from the current value stored in the file. Only positive values are allowed for the Debit command.

Depending on the communication mode the value is either transferred plain (4 bytes), enciphered (8 bytes enciphered data: 4 bytes value, 2 bytes CRC, 2 bytes padding with 0x00) or MACed (4 bytes value + 4 bytes MAC).

The value is always represented LSB first.

It is necessary to validate the updated value with a CommitTransaction command, see chapter 4.6.10. An AbortTransaction command will invalidate all changes, see chapter 4.6.11.

The value modifications of Credit, Debit and LimitedCredit commands are cumulated until a CommitTransaction command is issued.

The Debit command requires a preceding authentication with one of the keys specified for Read, Write or Read&Write access, see chapter 3.3.

If the usage of the LimitedCredit feature is enabled, the new limit for a subsequent LimitedCredit command is set to the sum of Debit commands within one transaction before issuing a CommitTransaction command. This assures that a LimitedCredit command can not re-book more values than a debiting transaction deducted before.

Functional Specification

mifare DESFire MF3 IC D40

4.6.6 LimitedCredit

The LimitedCredit command allows a limited increase of a value stored in a Value File without having full Read&Write permissions to the file. This feature can be enabled or disabled during value file creation.

LimitedCredit(FileNo,Data) [6/10 bytes]

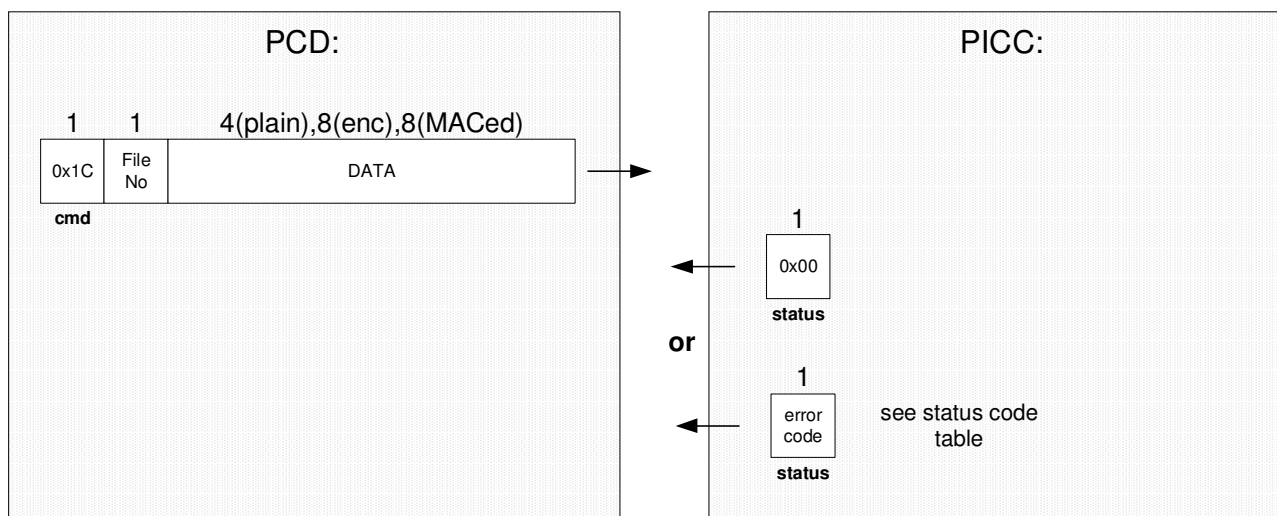

The first parameter sent with this command is of one byte length and codes the file number. This parameter has to be in the range from 0x00 to 0x07.

This command increases the current value stored in the file by a certain amount (4 byte signed integer) which is transmitted in the data field. Only positive values are allowed for the LimitedCredit command.

Depending on the communication mode the value is either transferred plain (4 bytes), enciphered (8 bytes enciphered data: 4 bytes value, 2 bytes CRC, 2 bytes padding with 0x00) or MACed (4 bytes value + 4 bytes MAC).

The value is always represented LSB first.

It is necessary to validate the updated value with a CommitTransaction command, see chapter 4.6.10. An AbortTransaction command will invalidate all changes, see chapter 4.6.11.

The value modifications of Credit, Debit and LimitedCredit commands are cumulated until a CommitTransaction command is issued.

The LimitedCredit command requires a preceding authentication with the key specified for "Write" or "Read & Write" access, see chapter 3.3.

The value for LimitedCredit is limited to the sum of the Debit commands on this value file within the most recent transaction containing at least one Debit. After executing the LimitedCredit command the new limit is set to 0 regardless of the amount which has been re-booked. Therefore the LimitedCredit command can only be used **once** after a Debit transaction.

Functional Specification

mifare DESFire MF3 IC D40

4.6.7 WriteRecord

The WriteRecord command allows to write data to a record in a Cyclic or Linear Record File.

WriteRecord(FileNo,Offset,Length,Data) [8+bytes]

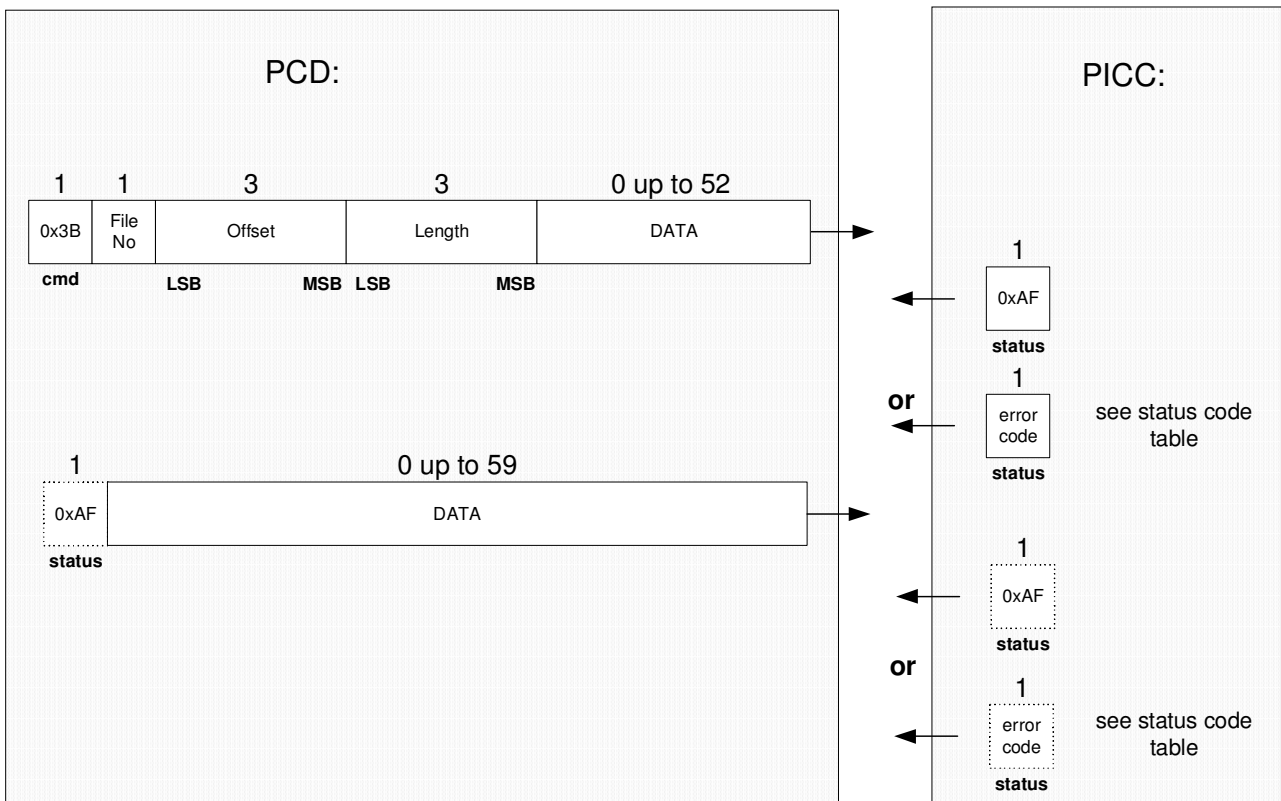

The first parameter is of one byte length and codes the file number. This parameter has to be in the range from 0x00 to 0x07.

The next three bytes code the offset within one single record (in bytes). This parameter has to be in the range from 0x00 00 00 to record size - 1.

This parameter is followed by another three bytes coding the length of data which is to be written to the record file. This parameter has to be in the range from 0x00 00 01 to record size - offset.

The WriteRecord command appends one record at the end of the linear record file, it erases and overwrites the oldest record in case of a cyclic record file if it is already full. The entire new record is cleared before data is written to it.

If no CommitTransaction command (see chapter 4.6.10) is sent after a WriteRecord command, the next WriteRecord command to the same file writes to the already created record. After sending a CommitTransaction command, a new WriteRecord command will create a new record in the record file. An AbortTransaction command will invalidate all changes, see chapter 4.6.11.

After issuing a ClearRecordFile command, but before a CommitTransaction / AbortTransaction command, a WriteRecord command to the same record file will fail.

Functional Specification**mifare DESFire MF3 IC D40**

Depending on the communication settings, see chapter 3.2, linked to the file, data needs to be sent by the PCD either plain, MACed or enciphered. All cryptographic operations are done in CBC mode.

For MACed- and enciphered communication padding on the data is necessary to reach an overall data-length of multiples of eight. This padding is done with all 0x00.

The WriteRecord command requires a preceding authentication either with the key specified for "Write" or "Read&Write" access, see chapter 3.3.

NOTE: In case of MACing the padding bytes are only used for cryptographic purpose but NOT exchanged between PCD and PICC.

Functional Specification

mifare DESFire MF3 IC D40

4.6.8 ReadRecords

The ReadRecords command allows to read out a set of complete records from a Cyclic or Linear Record File.

ReadRecords(FileNo,Offset,Length) [8bytes]

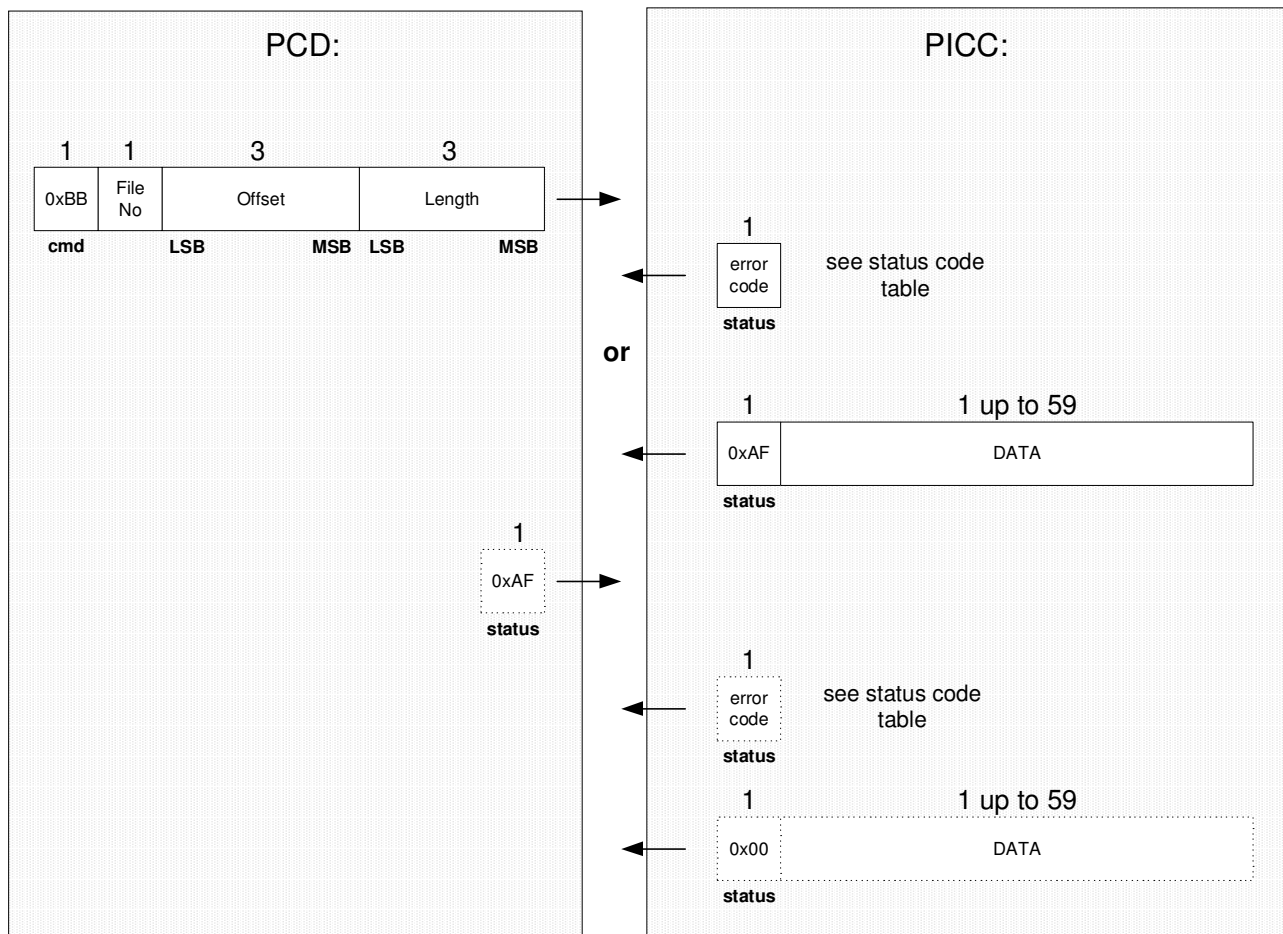

The first parameter is of one byte length and codes the file number in the range from 0x00 to 0x07.

The next parameter is three bytes long and codes the offset of the newest record which is read out. In case of 0x00 00 00 the latest record is read out. The offset value must be in the range from 0x00 to number of existing records – 1.

The third parameter is another three bytes which code the number of records to be read from the PICC. Records are always transmitted by the PICC in chronological order (= starting with the oldest, which is number of records – 1 before the one addressed by the given offset). If this parameter is set to 0x00 00 00 then all records, from the oldest record up to and including the newest record (given by the offset parameter) are read.

The allowed range for the number of records parameter is from 0x00 00 00 to number of existing records – offset.

Note: In cyclic record files the maximum number of stored valid records is one less than the number of records specified in the CreateCyclicRecordFile command.

Functional Specification**mifare DESFire MF3 IC D40**

A ReadRecords command on an empty record file (directly after creation or after a committed clearance, see chapter 4.6.9) will result in an error.

The ReadRecords command requires a preceding authentication either with the key specified for “Read” or “Read&Write” access, see chapter 3.3.

Depending on the communication settings, see chapter 3.2, linked to the file, data will be sent by the PICC either plain, MACed or enciphered. All cryptographic operations are done in CBC mode.

For MACed- and enciphered communication padding on the data is necessary to reach an overall data-length of multiples of eight. In case of a specified number of records (command parameter Length ≠ 0x00 00 00) padding is done with all 0x00.

Only in case enciphered communication AND the file is read until it's limit (command parameter Length = 0x00 00 00), the first byte appended for padding is 0x80, all other bytes appended are 0x00 (in accordance with ISO 9797-1).

NOTE: In case of MACing the padding bytes are only used for cryptographic purpose but NOT exchanged between PCD and PICC.

Functional Specification

mifare DESFire MF3 IC D40

4.6.9 ClearRecordFile

The ClearRecordFile command allows to reset a Cyclic or Linear Record File to the empty state.

ClearRecordFile(FileNo) [2 bytes]

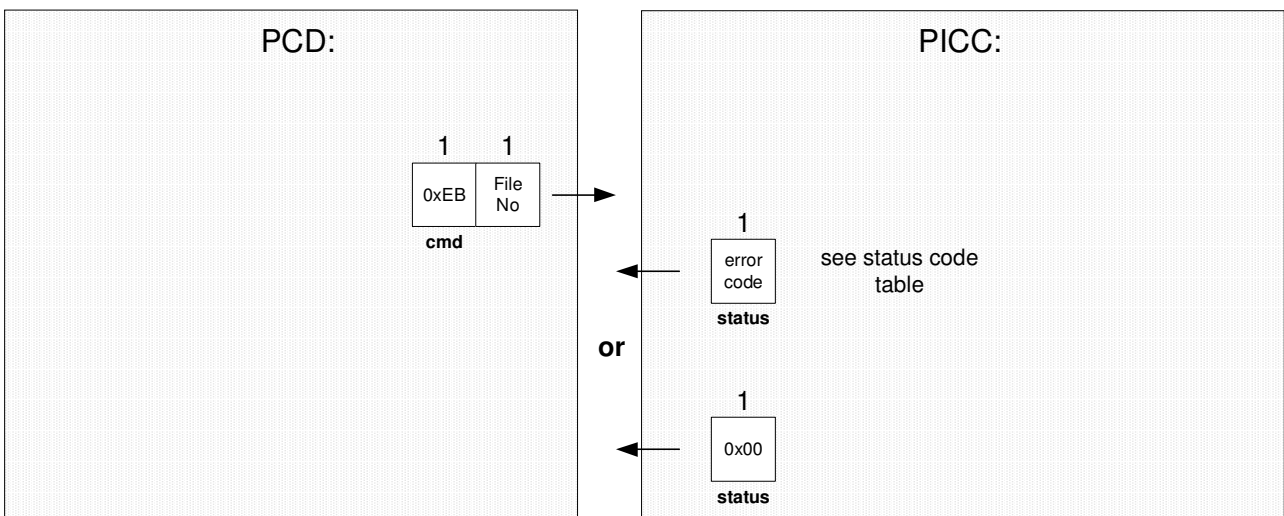

The only parameter sent with this command is of one byte length and codes the file number in the range from 0x00 to 0x07.

After executing the ClearRecordFile command but before CommitTransaction, all subsequent WriteRecord commands, see chapter 4.6.7, will fail. The ReadRecords command, see chapter 4.6.8, will return the old still valid records.

After the CommitTransaction command is issued, a ReadRecords command will fail, WriteRecord commands will be successful.

An AbortTransaction command (instead of CommitTransaction) will invalidate the clearance, see chapter 4.6.11.

Full "Read&Write" permission on the file is necessary for executing this command, see chapter 3.3.

Functional Specification

mifare DESFire MF3 IC D40

4.6.10 CommitTransaction

The CommitTransaction command allows to validate all previous write access on Backup Data Files, Value Files and Record Files within one application.

CommitTransaction(AID) [1 bytes]

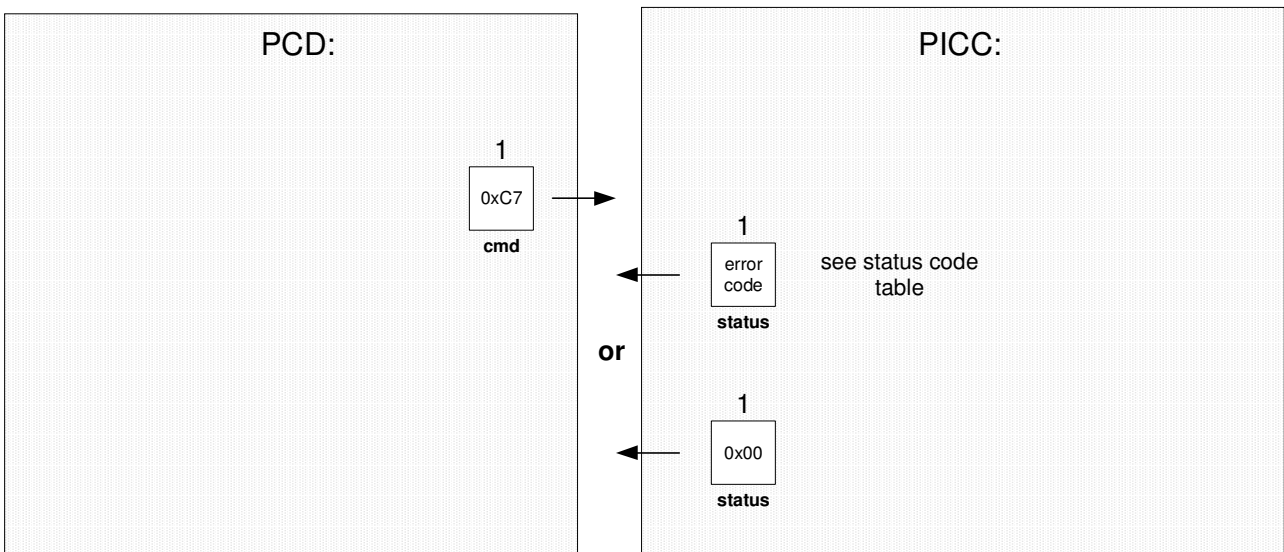

This command takes no parameter.

The CommitTransaction command validates all write access to files with integrated backup mechanisms:

- Backup Data Files
- Value Files
- Linear Record Files
- Cyclic Record Files

The CommitTransaction is typically the last command of a transaction before the ISO 14443-4 Deselect command or before proceeding with another application (SelectApplication command).

As logical counter-part of the CommitTransaction command the AbortTransaction command allows to invalidate changes on files with integrated backup management, see chapter 4.6.11.

Functional Specification

mifare DESFire MF3 IC D40

4.6.11 AbortTransaction

The AbortTransaction command allows to **invalidate** all previous write access on Backup Data Files, Value Files and Record Files within one application.

This is useful to cancel a transaction without the need for re-authentication to the PICC, which would lead to the same functionality.

AbortTransaction(AID) [1 bytes]

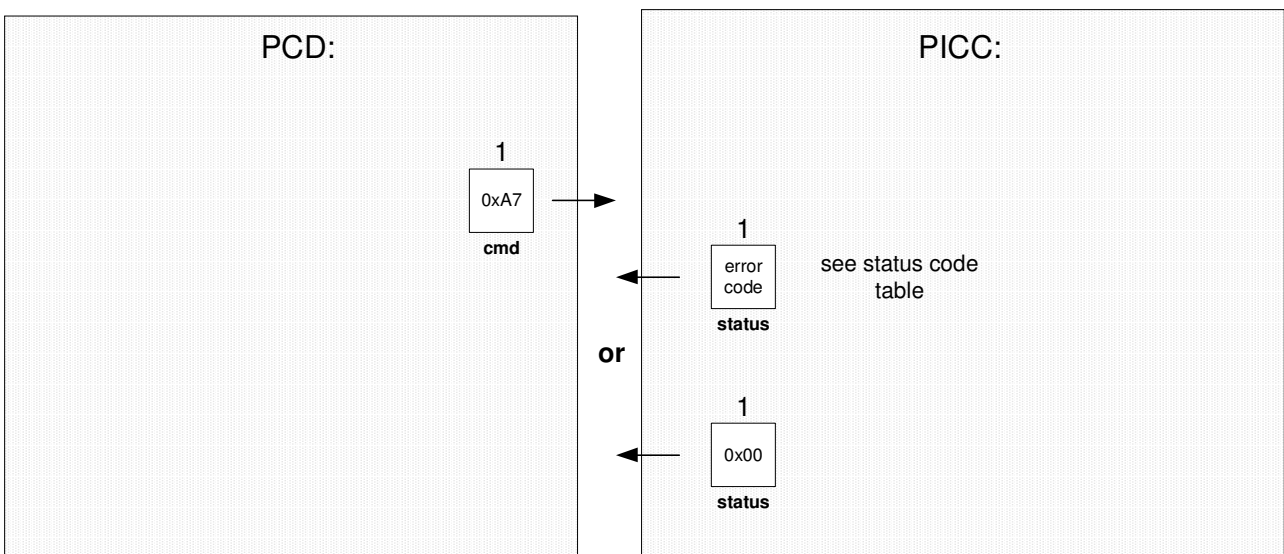

This command takes no parameter.

The AbortTransaction command **invalidates** all write access to files with integrated backup mechanisms without changing the authentication status:

- Backup Data Files
- Value Files
- Linear Record Files
- Cyclic Record Files

Functional Specification

mifare DESFire MF3 IC D40

4.7 Command Set ISO 7816-4 – Basic interindustry commands:

The MF3 IC D40 provides the following command set according to ISO 7816-4 clause 6:

4.7.1 ISO SELECT APPLICATION command

CLA	INS	P1	P2	L _c	Data	L _E
0x00	0xA4	Mode of Sel.	Opt.	Length of AID	AID	-

Description:

This APDU selects an ISO Application by its ISO Application Identifier (AID). The ISO AID of DESFire is "0xD2 76 00 00 85 01 00". The full ISO AID has to be transmitted, partial selection is NOT supported.

Other ISO AIDs are not supported by DESFire.

Detailed Description of the APDU Fields

Byte	Data	Remarks
P1	Mode of Selection	Fixed to 0x04, Select by Application; Data Field contains an ISO AID
P2	Option	Fixed to 0x00, first or only occurrence, no FCI information returned
L _c	Length	Fixed to 0x07
Data	AID	The data field holds the DESFire ISO AID.

Response APDU

Data	SW1	SW2	Remarks
-	0x90	0x00	Correct execution
-	0x6A	0x82	Application not found, currently selected application remains selected.
-	0x6A	0x86	Incorrect parameters P1-P2
-	0x6A	0x87	L _c inconsistent with P1-P2
-	0x6F	0x00	No precise diagnostics

Functional Specification

mifare DESFire MF3 IC D40

4.7.2 ISO SELECT DIRECTORY command

CLA	INS	P1	P2	L _c	Data	L _E
0x00	0xA4	Mode of Sel.	Opt.	Length	Directory Name	-

Description:

This APDU selects a DESFire Application by its three byte DESFire Application Identifier (DESFire AID). The Application can then be the object of subsequent file operations such as READ BINARY or UPDATE BINARY using their implicit file selection option.

The functionality of the ISO SELECT DIRECTORY Command is compatible with the native DESFire "Select Application" command.

Detailed Description of the APDU Fields

Byte	Data	Remarks
P1	Mode of Selection	Fixed to 0x04, Select by Directory Name
P2	Option	Fixed to 0x00, first or only occurrence, no FCI information returned
L _c	Length	Fixed to 0x03, as DESFire supports only 3 byte Directory Names
Data	Directory Name	Name of Directory to select

Response APDU

Data	SW1	SW2	Remarks
-	0x90	0x00	Correct execution
-	0x6A	0x82	DESFire AID not found, currently selected DESFire AID remains selected.
-	0x6A	0x86	Incorrect parameters P1-P2
-	0x6A	0x87	L _c inconsistent with P1-P2
-	0x6F	0x00	No precise diagnostics

Functional Specification

mifare DESFire MF3 IC D40

4.7.3 ISO SELECT FILE command

CLA	INS	P1	P2	L _c	Data	L _E
0x00	0xA4	Mode of Sel.	Opt.	Length of Data	ISO File ID	-

Description:

Based on the transmitted ISO File ID, this APDU selects a DESFire AID and DESFire FID. The Application can then be the object of subsequent file operations such as READ BINARY or UPDATE BINARY without using their implicit file selection option.

The functionality of the Select File Command includes an implicit DESFire “Select Application” command.

Detailed Description of the APDU Fields

Byte	Data	Remarks									
P1	Mode of Selection	Fixed to 0x00, Select by File ID; Data Field contains an AID									
P2	Option	Fixed to 0x00, first or only occurrence, no FCI information returned									
L _c	Length	Fixed to 0x02									
Data	File ID	<p>The data field contains the DESFire FID in the lowest nibble of the last ISO File ID data byte.</p> <p>The rest of the ISO File ID is padded with 0xE nibbles from the left to construct a DESFire AID.</p> <p>Example:</p> <table border="1"> <thead> <tr> <th>File ID</th> <th>DESFire AID</th> <th>DESFire FID</th> </tr> </thead> <tbody> <tr> <td>0x00 07</td> <td>0xEE E0 00</td> <td>0x07</td> </tr> <tr> <td>0xDB 00</td> <td>0xEE ED B0</td> <td>0x00</td> </tr> </tbody> </table>	File ID	DESFire AID	DESFire FID	0x00 07	0xEE E0 00	0x07	0xDB 00	0xEE ED B0	0x00
File ID	DESFire AID	DESFire FID									
0x00 07	0xEE E0 00	0x07									
0xDB 00	0xEE ED B0	0x00									

Response APDU

Data	SW1	SW2	Remarks
-	0x90	0x00	Correct execution
-	0x6A	0x82	DESFire AID and/or DESFire FID not found
-	0x6A	0x86	Incorrect parameters P1-P2
-	0x6A	0x87	L _c inconsistent with P1-P2
-	0x6F	0x00	No precise diagnostics

Functional Specification

mifare DESFire MF3 IC D40

Use of 1, 3 or 4 byte File IDs:

File IDs with 1, 3 or 4 byte are also possible on DESFireG (but not specified in ISO 7816):

Byte	Data	Remarks												
P1	Mode of Selection	Fixed to 0x00, Select by File ID; Data Field contains an AID												
P2	Option	Fixed to 0x00, first or only occurrence, no FCI information returned												
L _c	Length	Up to 4 bytes												
Data	File ID	<p>The data field contains the DESFire FID in the lowest nibble of the last ISO File ID data byte.</p> <p>The rest of the ISO File ID is padded with 0xE nibbles from the left to construct a DESFire AID.</p> <p>In case a 4 byte ISO File ID is sent, the highest nibble is ignored by DESFire.</p> <p>Example:</p> <table border="1"> <thead> <tr> <th>File ID</th> <th>DESFire AID</th> <th>DESFire FID</th> </tr> </thead> <tbody> <tr> <td>0x07</td> <td>0xEE EE E0</td> <td>0x07</td> </tr> <tr> <td>0xAA BB CC</td> <td>0xEA AB BC</td> <td>0x0C</td> </tr> <tr> <td>0x11 22 33 44</td> <td>0x12 23 34</td> <td>0x04</td> </tr> </tbody> </table>	File ID	DESFire AID	DESFire FID	0x07	0xEE EE E0	0x07	0xAA BB CC	0xEA AB BC	0x0C	0x11 22 33 44	0x12 23 34	0x04
File ID	DESFire AID	DESFire FID												
0x07	0xEE EE E0	0x07												
0xAA BB CC	0xEA AB BC	0x0C												
0x11 22 33 44	0x12 23 34	0x04												

Response APDU

Data	SW1	SW2	Remarks
-	0x90	0x00	Correct execution
-	0x6A	0x82	DESFire AID and/or DESFire FID not found
-	0x6A	0x86	Incorrect parameters P1-P2
-	0x6A	0x87	L _c inconsistent with P1-P2
-	0x6F	0x00	No precise diagnostics

Functional Specification

mifare DESFire MF3 IC D40

4.7.4 ISO READ BINARY command

CLA	INS	P1	P2	L _c	Data	L _E
0x00	0xB0	Short file ID / Offset	-	-	-	Bytes to be Read

Description:

Reads up to 59 bytes from a binary file (“Standard Data File” or “Backup Data File”). Only short file IDs 0 to 15 are supported. The offset is limited to 15 bits (0...32767).

The offset is limited to 1 byte (0...255) if the file ID is also provided. The File ID is optional when the File has previously been opened with the ISO SELECT FILE command or with a previous ISO READ BINARY or ISO UPDATE BINARY with File ID.

If a short file ID is used and no DESFire AID is selected before issuing this command (no ISO SELECT FILE command or ISO SELECT DIRECTORY command issued), DESFire will select the DESFire AID “0xEE E0 00” automatically.

The Read Binary command is limited to the use of files with the DESFire Access Right for “read only access” and / or the “read & write access” set to key “0xE”, indicating free access without cryptographic operations.

Detailed Description of the APDU Fields

Byte	Data	Remarks
P1 / P2	Short File ID / Offset	If bit 8 is set to zero in P1, then P1-P2 code the offset from zero to 32767 (fifteen bits). If bit 8 is set to one in P1, then bits 7 to 5 of P1 are set to 0 (RFU bits), bits 4 to 1 of P1 code a short DESFire FID and bits 8 to 1 of P2 code the offset from zero to 255 (eight bits).
L _E	Bytes to Read	The number of bytes to read from the file. The allowed range is 1 to 59 bytes.

Response APDU

Data	SW1	SW2	Remarks
Data (up to 59 bytes)	0x90	0x00	Command OK
-	0x67	0x00	Wrong length
-	0x69	0x82	File Access not allowed
-	0x6A	0x82	File not found
-	0x6B	0x00	Wrong parameter P1 and/or P2
-	0x6F	0x00	No precise diagnostics

Functional Specification

mifare DESFire MF3 IC D40

4.7.5 ISO UPDATE BINARY command

CLA	INS	P1	P2	L _c	Data	L _E
0x00	0xD6	Short file ID / Offset		Bytes to write	Data (up to 52 bytes)	-

Description:

Writes up to 52 bytes to a binary file (DESFire “Standard Data File” or “Backup Data File”). Only File IDs 0 to 15 are supported. The offset is limited to 15 bits (0 .. 32767).

The offset is limited to 1 byte (0 .. 255) if the File ID is also provided. The File ID is optional if the file has previously been opened with the “Select File” command or with a previous “Read Binary” or “Update Binary” including a File ID.

If a short file ID is used and no DESFire AID is selected before issuing this command (no ISO SELECT FILE command or ISO SELECT DIRECTORY command issued), DESFire will select the DESFire AID “0xEE E0 00” automatically.

If a “Backup Data File” is used, the DESFire issues an implicit “Commit Transaction” command. This ensures that every update of a binary file is treated as a transaction.

The ISO UPDATE BINARY command is limited to the use of files with the Access Right for “write only access” and / or “read & write access” set to key “0xE”, indicating free access without cryptographic operations.

Detailed Description of the APDU Fields

Byte	Data	Remarks
P1 / P2	Short File ID / Offset	If bit 8 is set to zero in P1, then P1-P2 code the offset from zero to 32767 (fifteen bits). If bit 8 is set to one in P1, then bits 7 to 5 of P1 are set to 0 (RFU bits), bits 4 to 1 of P1 code a short DESFire FID and bits 8 to 1 of P2 code the offset from zero to 255 (eight bits).
L _c	Bytes to Write	The number of bytes to write to the file. Maximum number of bytes is 52.

Response APDU

Data	SW1	SW2	Remarks
Data (up to 52 bytes)	0x90	0x00	Command OK
-	0x65	0x81	Memory failure (unsuccessful updating)
-	0x67	0x00	Wrong length
-	0x69	0x82	File Access not allowed
-	0x6A	0x82	File not found
-	0x6B	0x00	Wrong parameter P1 and/or P2
-	0x6F	0x00	No precise diagnostics

Functional Specification

mifare DESFire MF3 IC D40

5 DEFINITIONS

Data sheet status	
Objective specification	This data sheet contains target or goal specifications for product development.
Preliminary specification	This data sheet contains preliminary data; supplementary data may be published later.
Product specification	This data sheet contains final product specifications.
Limiting values	
Limiting values given are in accordance with the Absolute Maximum Rating System (IEC 134). Stress above one or more of the limiting values may cause permanent damage to the device. These are stress ratings only and operation of the device at these or at any other conditions above those given in the Characteristics section of the specification is not implied. Exposure to limiting values for extended periods may affect device reliability.	
Application information	
Where application information is given, it is advisory and does not form part of the specification.	

6 LIFE SUPPORT APPLICATIONS

These products are not designed for use in life support appliances, devices, or systems where malfunction of these products can reasonably be expected to result in personal injury. Philips customers using or selling these products for use in such applications do so on their own risk and agree to fully indemnify Philips for any damages resulting from such improper use or sale.

Functional Specification**mifare DESFire MF3 IC D40**

7 REVISION HISTORY**Table 1** Objective Specification MF3 IC D40 Revision History

REVISION	DATE	CPCN	PAGE	DESCRIPTION
3.1	April 2004			Integration of ISO 7816 Features
3.0	April 2004			Product Version
2.0	April 2003			Preliminary Version
1.0	July 2002			First official version.

Philips Semiconductors - a worldwide company

Contact Information

For additional information please visit <http://www.semiconductors.philips.com>. Fax: +31 40 27 24825

For sales offices addresses send e-mail to: sales.addresses@www.semiconductors.philips.com.

© Koninklijke Philips Electronics N.V. 2002

SCA74

All rights are reserved. Reproduction in whole or in part is prohibited without the prior written consent of the copyright owner.

The information presented in this document does not form part of any quotation or contract, is believed to be accurate and reliable and may be changed without any notice. No liability will be accepted by the publisher for any consequence of its use. Publication thereof does not convey nor imply any license under patent- or other industrial or intellectual property rights.

Let's make things better.

**Philips
Semiconductors**



PHILIPS